

100 - 240V

Information subject to change without notice



## OVERVIEW

## ORDERING INFORMATION

### Fixture Overview

High End Systems' SolaSpot 3000 combines unprecedented light output from its 1000 watt Ultra-Brite White LED engine with a limitless palette of effects and color possibilities. Engineered for the largest lighting applications, SolaSpot 3000 is the first automated LED luminaire to rival and even exceed the output of the most powerful arc lamp fixtures, while simultaneously offering the advantages of LED technology such as long engine life.

### Applications

- Arenas and stadiums
- Concert halls and performing arts centers
- Film and television broadcast studios
- Large scale events
- Megachurches and houses of worship

### Product Features

- White LED Engine
- 1000W Ultra-Brite engine producing 37,000 field lumens or High Fidelity Engine with incredibly accurate color rendering
- CMY / CTO - Linear color mixing system
- Six + open position replaceable Color Wheel
- Iris, Light Frost
- Two rotating Prisms
- 7°-55° Zoom
- Seven position plus open interchangeable Gobo Wheel
- Two, Seven position plus open Rotating Gobo Wheels
- Two continuously Variable Animation Wheels
- TM30 Filter Boosts Ultra-Brite Engine to 85+ CRI
- Patented Lens Defogger

### SolaSpot 3000

Model	Description
2581A1100	SolaSpot 3000 fixture, Ultra-Brite, black, with Road Case
2581A1100-B	SolaSpot 3000 fixture, Ultra-Brite, black, with Molded Rubber Insert
2581A1100-F	SolaSpot 3000 fixture, Ultra-Brite, black
2581A1101	SolaSpot 3000 fixture, High Fidelity, black, with Road Case
2581A1101-B	SolaSpot 3000 fixture, High Fidelity, black, with Road Molded Rubber Insert
2581A1101-F	SolaSpot 3000 fixture, High Fidelity, black

Color Options: Fixtures ship standard in black. White available by request.

Notes: Fixture includes two (2) Omega Brackets and one (1) Fixture Power Cord, Bare Ends to powerCON TRUE1™ Input, one (1) safety cable.

### Accessories

Model #	Description
2560B7004	Fixture Power Cord upgrade, 5-20 Edison to powerCON TRUE1™, 20A
2560B7005	Fixture Power Cord upgrade, Stage Pin to powerCON TRUE1™, 20A
2560B7006	Fixture Power Cord upgrade, L6-20 to powerCON TRUE1™, 20A
2560B7007	Fixture Power Cord upgrade, L5-20 to powerCON TRUE1™, 20A
67040007	MegaClaw™
55040014	Cheeseborough 2" Alloy 1/2 Coupler Truss Clamp
67040010	Mini-Claw™



## PRODUCT SPECIFICATIONS

### Source

Engine Options	Ultra-Brite white engine	High Fidelity white engine
LED Details	1000W	1000W
Max Lumens on the Wall	37,000 Lumens	25,000 Lumens
LPW	37 Lumens per Watt	25 Lumens per Watt
LED Life	50,000 hours	50,000 hours
Native CCT	7000k	6000k

### Color

Color Mixing	Cyan, Magenta, Yellow, CTO-Linear
Color Temperature	Variable down to 2800k
Color Wheel	Six (6) interchangeable dichroic chips plus open includes TM-30 Filter standard
Notes	See Page 5 for color rendering information

### Optical

Beam angle range	7° - 55°
Gate size	30 mm
Aperture size	120 mm
Pattern Projection	Two rotating and indexable wheels with seven (7) patterns plus open Fixed wheel with seven (7) patterns plus open
Prism	Three-facet rotating and indexable prism and Eight-facet rotating and indexable prism Additional accessories available
Frost	Light and Heavy Frosts Additional accessories available
Flicker control/Hz range	2.4 khz or 16 khz
Animation	Graphical rotating animation wheel and Glass textured rotating animation wheel
Iris	16 Blade Iris
Notes	See page 3 for additional gobo information

### Control

Input method	DMX (5-pin) or Ethernet
Protocols	DMX via RS-485 ArtNet or sACN via Ethernet
Modes (Footprint)	one (47)
RDM functions	Yes
UI type	Full color graphical UI with 6 button navigational control
Local control	Yes
Dimming performance	16-Bit, DMX Controlled

### Electrical

Voltage range	100-240V 50-60Hz
Input method	powerCON TRUE1
Wattage	See Page 6 for wattage table
Current	See Page 6 for current table
Notes	See Page 6 for power factor information

### Thermal

Ambient operating temp	-10 to 45° C (14 to 113° F)
Fan	Three Modes: Standard, Studio, and Continuous
Stationary dBA/Full intensity	Standard - 42 dBA Studio - 38 dBA Continuous - 44 dBA

### Physical

Pan and Tilt Range	540 Pan, 265 Tilt
Max Pan/Tilt Speed	360° in 2.65s / 180° in 1.58s
Materials	Steel and aluminum frame with molded plastic covers
Color options	Black, White by request
Mounting options	Any Orientation
IP rating	IP-20
Weight	103 lbs (46.7 kg)
Included accessories	powerCON TRUE1 to bare end fixture tail Two (2) clamp Brackets Safety Cable
Notes	See page 6 for dimensions

### Warranty

Fixture Warranty	Five (5) years for light engine Two (2) year for complete fixture
Warranty Details	<a href="https://www.highend.com/warranty/">https://www.highend.com/warranty/</a>

### Regulatory & Compliance

Approved Regulatory Standards	Conforms to UL STD.1573 Certified to CSA STD. C22.2 No: 166 CE
-------------------------------	--

### Safety

Safety	Minimum distance to illuminated surface = 2.0 m Minimum distance from fixture head to combustible materials = 0.1 m
--------	--

### Notes about LED luminaires

All LED sources experience some lessening of light output and some color shift over time. LED output will vary with thermal conditions. Thermal conditions can be affected by ambient temperatures and orientation.



## OPTICAL INFORMATION

### Fixed Gobo Dimensions

Outside Diameter	30 mm (1.18 in)
Image Diameter	25 mm (.98 in)
Materials	0.5 mm Aluminum

### Rotating Gobo Dimensions

Outside Diameter	30 mm (1.18 in)
Image Diameter	25 mm (.98 in)
Materials	0.5 mm Aluminum or 1.1 mm Glass Borofloat

### Interchangeable Color Wheel



1 - Red



2 - Light Blue



3 - Green



4 - TM-30



5 - Orange



6 - Dark Blue

### Fixed Gobo Wheel



1 - Tunnel



2 - Triangles



3 - Organic

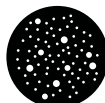

4 - Shower



5 - Abstract



6 - Cobble



7 - Endgrain

### Rotating Gobo Wheel 1



1 - Bar



2 - Stripe Strips



3 - Crescents



4 - GeoSwirl



5 - Seashell  
(Magnetically indexed  
adaptor)



6 - Pinwheel Dots

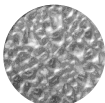

7 - Ice

### Rotating Gobo Wheel 2



1 - Zoetrope



2 - Jungle



3 - Thin Branches



4 - Tiny Triangles



5 - Starvolver  
(Magnetically indexed  
adaptor)



6 - Stainglass



7 - 31 Box

### Animation Wheel 1

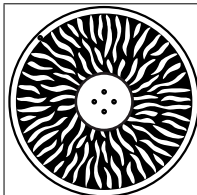

Continuously rotating  
graphical animation  
wheel

### Animation Wheel 2

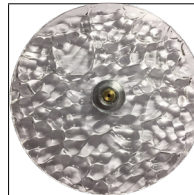

Continuously rotating  
glass animation wheel

## PHOTOMETRIC INFORMATION

### SolaSpot 3000 - Ultra-Brite

Mode	Degree	Candela	Field Lumens	Power Consumption	Lumens Per Watt
Narrow	7	1,258,510	14,749	1000W	14.7
Medium	30	35,454	29,000	1000W	29
Wide	55	49,018	37,000	1000W	35
Wide w/ Frost	60	38,648	32,534	1000W	32.5

Metric conversions: For meters, multiply feet by 0.3048  
For lux, multiply footcandles by 10.76

### SolaSpot 3000 - High Fidelity

Mode	Degree	Candela	Field Lumens	Power Consumption	Lumens Per Watt
Narrow	7	900,557	10,554	1000W	10.5
Medium	30	97,625	20,901	1000W	20.9
Wide	55	34,351	24,387	1000W	24.3
Wide w/ Frost	60	27,797	23,400	1000W	23.4

Metric conversions: For meters, multiply feet by 0.3048  
For lux, multiply footcandles by 10.76

### Narrow Zoom - 7 Degrees

Throw Distance (d)	10ft	15ft	20ft	25ft	188.7ft
	3.0m	4.6m	6.1m	7.6m	57.5m
Field Diameter	1.2ft	1.8ft	2.4ft	3.1ft	23.4ft
	0.37m	0.56m	0.75m	0.93m	7.13m
Illuminance (fc)	14,075	6,172	3,473	2,234	39
Illuminance (lux)	151,510	66,442	37,391	24,047	422

### Narrow Zoom - 7 Degrees

Throw Distance (d)	10ft	15ft	20ft	25ft	188.7ft
	3.0m	4.6m	6.1m	7.6m	57.5m
Field Diameter	1.2ft	1.9ft	2.5ft	3.1ft	23.4ft
	0.37m	0.57m	0.76m	0.94m	7.13m
Illuminance (fc)	10,126	4,440	2,499	1,607	28
Illuminance (lux)	109,000	47,800	26,900	17,300	304

### Medium Zoom - 30 Degrees

Throw Distance (d)	10ft	15ft	20ft	25ft	188.7ft
	3.0m	4.6m	6.1m	7.6m	57.5m
Field Diameter	5.4ft	8.0ft	10.7ft	13.4ft	101ft
	1.6m	2.4m	3.3m	4.1m	31m
Illuminance (fc)	6,779	3,198	1,911	1,247	22
Illuminance (lux)	72,975	34,333	20,572	13,427	236

### Medium Zoom - 30 Degrees

Throw Distance (d)	10ft	15ft	20ft	25ft	188.7ft
	3.0m	4.6m	6.1m	7.6m	57.5m
Field Diameter	5.4ft	8.0ft	10.7ft	13.4ft	101ft
	1.6m	2.4m	3.3m	4.1m	31m
Illuminance (fc)	4,877	2,294	1,374	897	16
Illuminance (lux)	52,500	24,700	14,800	9,660	170

### Wide Zoom - 55 Degrees

Throw Distance (d)	10ft	15ft	20ft	25ft	188.7ft
	3.0m	4.6m	6.1m	7.6m	57.5m
Field Diameter	10.4ft	15.6ft	20.8ft	26ft	196ft
	3.17m	4.76m	6.34m	7.93m	60m
Illuminance (fc)	601	273	157	104	1.8
Illuminance (lux)	6,477	2,974	1,695	1,120	20

To determine center beam illumination in footcandles at any throw distance, divide candela by the throw distance squared

For field diameter at any distance, multiply distance by 0.491  
For beam diameter at any distance, multiply by 0.274

### Wide Zoom - 55 Degrees

Throw Distance (d)	10ft	15ft	20ft	25ft	188.7ft
	3.0m	4.6m	6.1m	7.6m	57.5m
Field Diameter	10.4ft	15.6ft	20.8ft	26ft	23.4ft
	3.17m	4.76m	6.34m	7.93m	7.13m
Illuminance (fc)	432	198	113	74	1.3
Illuminance (lux)	4,660	2,140	1,220	806	20

To determine center beam illumination in footcandles at any throw distance, divide candela by the throw distance squared

For field diameter at any distance, multiply distance by 0.491  
For beam diameter at any distance, multiply by 0.274



## COLOR METRIC INFORMATION

Ultra-Brite Engine

### IES TM-30-15 Color Rendition Report

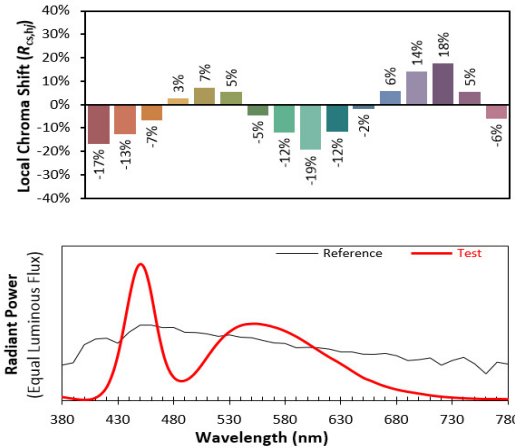
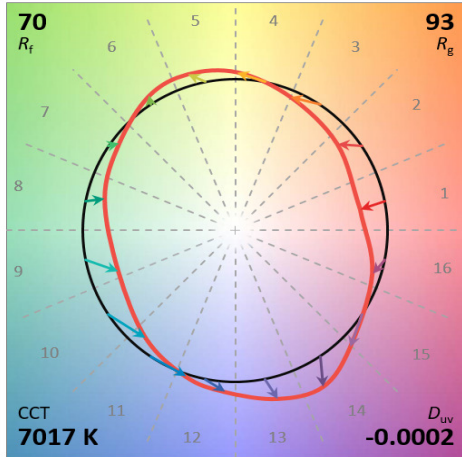

Colors are for visual orientation purposes only. Please contact ETC for full TM-30-15 report.

### Additional Color Metrics

SolaSpot 3000 Ultra-Brite Engine	
CRI $R_a$ ( $R_g$ )	70 (-14.5)
TLCI	47

Ultra-Brite Engine with TM-30 Filter

### IES TM-30-15 Color Rendition Report

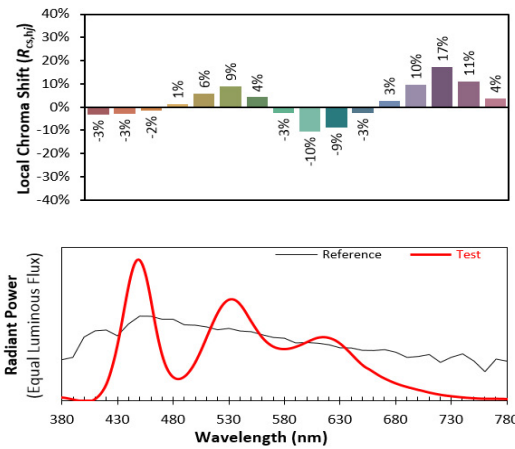
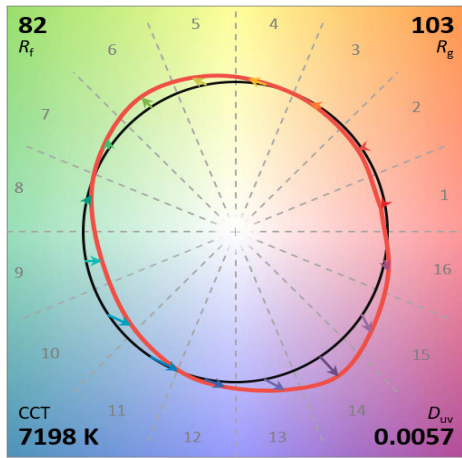

Colors are for visual orientation purposes only. Please contact ETC for full TM-30-15 report.

### Additional Color Metrics

SolaSpot 3000 Ultra-Brite Engine with TM-30 Filter	
CRI $R_a$ ( $R_g$ )	85 (70.2)
TLCI	84

High Fidelity Engine

### IES TM-30-15 Color Rendition Report

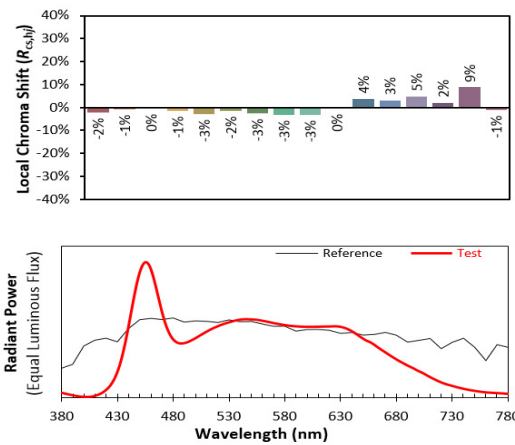
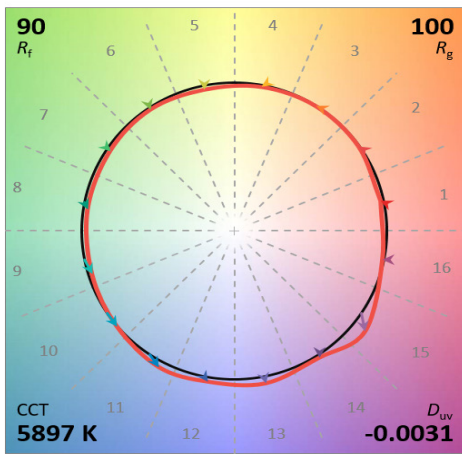

Colors are for visual orientation purposes only. Please contact ETC for full TM-30-15 report.

### Additional Color Metrics

SolaSpot 3000 High Fidelity Engine	
CRI $R_a$ ( $R_g$ )	96 (94)
TLCI	94



## PHYSICAL INFORMATION

### SolaSpot 3000 Dimensions

MODEL	HEIGHT		WIDTH		DEPTH		WEIGHT	
	in	mm	in	mm	in	mm	lb	kg
SolaSpot 3000*	32.3	821	19.3	491	14.5	368	103	46.7
SolaSpot 3000 in Box	28.2	715	27.2	690	22.7	575	124	56.2
SolaSpot 3000 in Molded Case Insert	28.2	715	27.2	690	22.7	575	147	66.5
SolaSpot 3000 in Roadcase	39.9	1013	28.9	735	26	661	236	107

\*Does not include mounting hardware

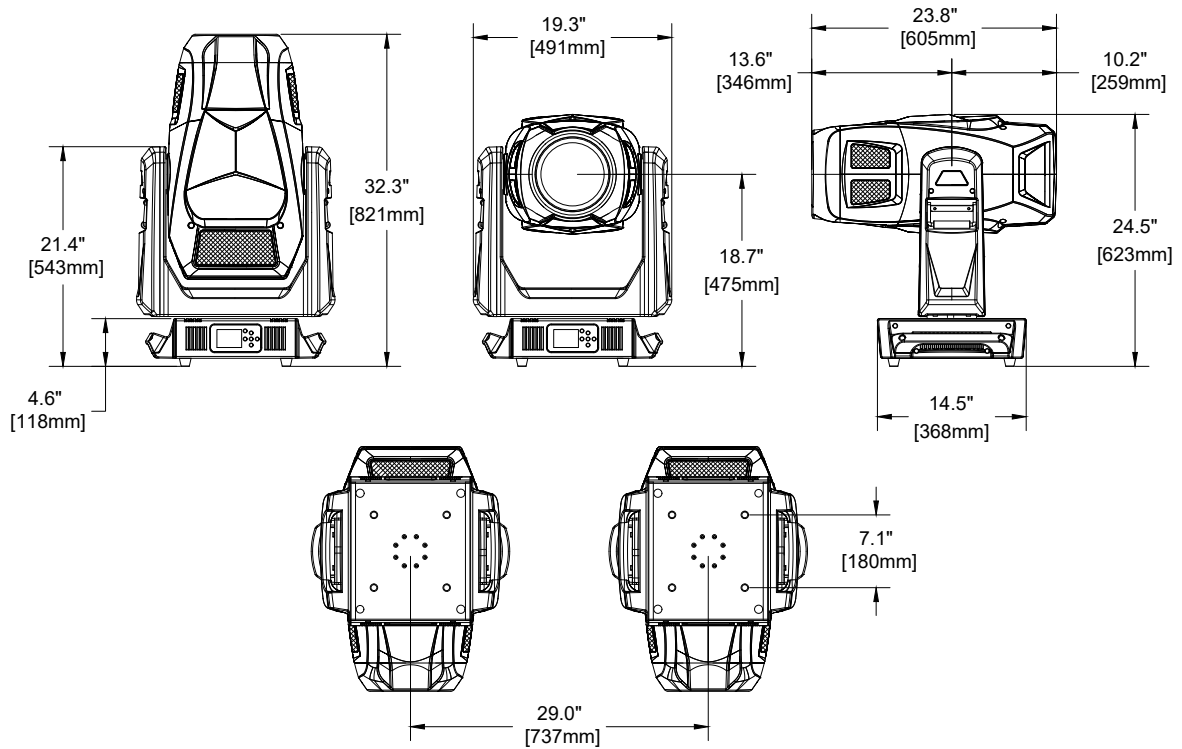

### SolaSpot 3000 Power Table

VAC	Amps	Hz	Watts	VA	PF	Crest Factor
100	14.7	50	1471	1461	0.99	1.40
120	11.8	60	1420	1416	0.99	1.41
200	6.6	50	1323	1322	0.99	1.49
208	6.3	60	1322	1326	0.99	1.47
220	6.0	50	1321	1346	0.99	1.51
240	5.5	60	1316	1324	0.98	1.50



## ADDITIONAL ORDERING INFORMATION

### Additional Accessories

MODEL	DESCRIPTION
2581A2015	Optional Four Facet Linear Prism Accessory (Not Installed)
PSR1082	Molded Case Insert
H7500001	Extra Omega Brackets
H7300105	Galvanized Safety Cable w/Spring Snap

### Molded Case Insert Dimensions

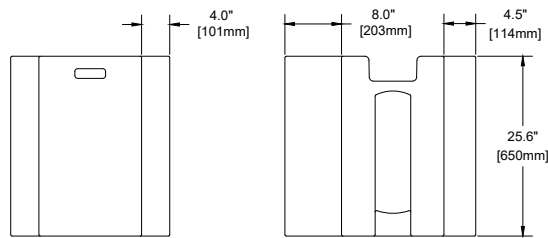
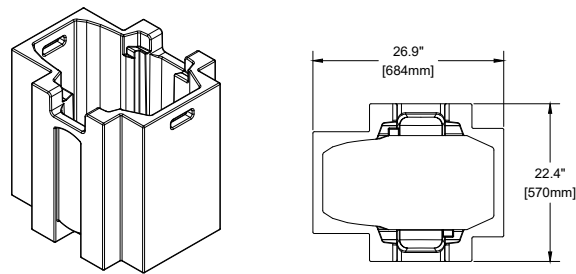

### Roadcase Dimensions (Single Mode)

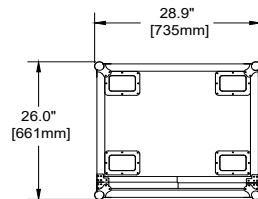

### (Dual Mode)

