

# TOPAZE - 1119

COMPACT - 1200 W MSD



- **Type:** Followspot
- **Source:** 1200 W MSD
- **PSU:** Magnetic
- **Optics:** 7° to 14,5° zoom

Followspot

## Economical yet full of features

The full range of features on Topaze brings Robert Juliat quality within reach of all budgets. Long lamp life and low running costs provide a powerful, cost-effective solution for mid-size theatres, shows and rental companies alike.

### Features

- **Fully closing iris cassette:** removable for fast, easy replacement; protective backplate for extended lifespan
- **Universal adjustable gobo holder:** "A" size glass and metal gobos
- **Ergonomic dimmer control:** one-handed dim, pan and tilt. Dimmer control can be adjusted to suit the operator's preference
- **Smooth dimmer shutter:** retains flat beam and colour temperature when dimming
- **Frost filter:** on flip lever for quick soft-edge beam effect
- **Horizontal chopper (optional):** for masking control in TV studios and wide stages
- **Internal glass filter holder:** long term use of durable coloured, dichroic or textured glass
- **Individually removable colour frame:** gels replaced easily while colour cassette remains in place
- **Colour changer:** 6-way, self-cancelling boomerang colour-changer
- **Easy focus reference:** graduated scale on side of lantern; fast and easy refocusing
- **Adjustable yoke (optional):** for optimum overhead positioning
- **Fine balance:** precision positioning and smooth operation even with the smallest movements
- **Stand:** perfectly weighted for maximum stability with smooth rotation for optimum performance. Easy set up; triple safety system for extra security

### Optical

- **Long lamp life (3000 h)**
- **Factory set optical train:** travels safely within followspot and requires no time-consuming realignment on arrival. Uniform beam on all followspots of same type
- **SX optical system:** double condenser optics for exceptional optical quality
- **Gobo :** excellent gobo projection
- **Variable zoom optics:** sharp focus at every beam angle. Independent control of image size and focus.

### Construction

- **Made in France :** fully manufactured in Robert Juliat premises retaining complete control over all aspects of quality
- **Separate PSU:** compact for easy handling and rapid maintenance
- **G22 socket locking system exclusive to Robert Juliat:** holds the lamp securely in place to ensure there is no arcing, even when the fixture is pointing vertically downward
- **Bodywork:** strong sheet metal construction for durability
- **Ergonomic wrap-around handle:** comfort, safety and practicality from all operating positions
- **Moving parts:** smooth at all times, even when hot
- **Captive knobs and handles:** additional security when working at height or in transit
- **Easy access to all parts:** easy cleaning, re-lamping and maintenance
- **Removable assemblies:** fast-plug cable connectors and complete component assemblies (mirror, condenser set and lamp house assembly) save maintenance and cleaning time

Picture:1119

DSEN095\_1119 - 28/03/2019

Robert Juliat reserves the right to change or alter any of the items detailed on this page, to increase or improve manufacturing techniques without prior notice.

Robert Juliat S.A.S., 32 rue de Beaumont, 60530 Fresnoy-en-Thelle - France  
Telephone : +33 (0)3 44 26 51 89 - fax : +33 (0)3 44 26 90 79 - info@robertjuliat.fr  
www.robertjuliat.com



ROBERT JULIAT

## Source



- **Lamp type:** Discharge
- **Power:** 1200 W
- **Socket:** G22
- **Hot re-strike:** no

Admissible lamps	Power *	Lumen output*	Colour temperature*	Life*	CRI* (min)
MSD 1200W (Philips )	1 200 W	92 000 lm	6000K	3 000 h	80

(\*) manufacturer's data

## Optics

### Characteristics

- **Type:** Zoom
- **Beam range:** 7° to 14,5°
- **Focal length:** 283 - 589 mm

### Gel filter

- **Shape:** Circle
- **Standard size:** 210 mm (8.3 in)

### Gobo

- **Size:** A
- **Material:** Metal  
Glass



## Photometrics

with MSD 1200W (Philips ) source

### • Optics @ 7°

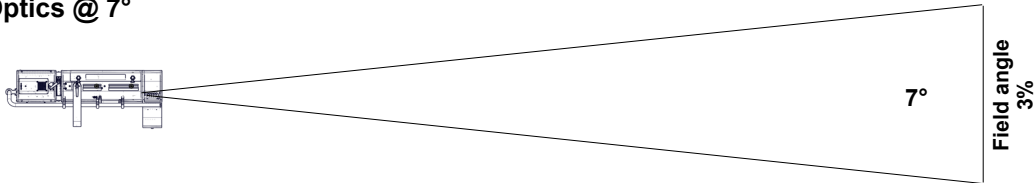

**Beam intensity**  
1 360 000 cd

<b>Distance</b>	15 m	20 m	25 m	30 m	35 m	40 m
<b>Diameter</b>	1.8 m	2.4 m	3.1 m	3.7 m	4.3 m	4.9 m
<b>Illumination</b>	6 100 lux	3 450 lux	2 200 lux	1 550 lux	1 150 lux	860 lux
<b>Distance</b>	50 ft	65 ft	80 ft	100 ft	115 ft	130 ft
<b>Diameter</b>	6.1 ft	8 ft	9.8 ft	12.2 ft	14.1 ft	15.9 ft
<b>Illumination</b>	550 fc	330 fc	220 fc	140 fc	110 fc	85 fc

### • Optics @ 14.5°

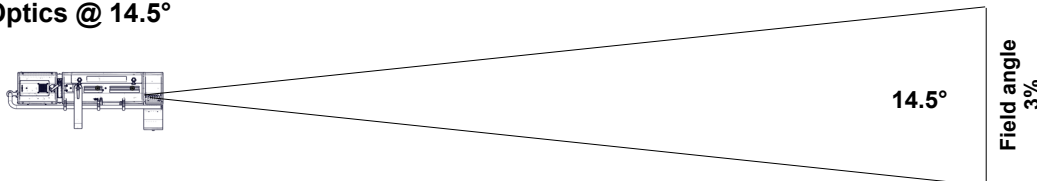

**Beam intensity**  
420 000 cd

<b>Distance</b>	15 m	20 m	25 m	30 m	35 m	40 m
<b>Diameter</b>	3.8 m	5.1 m	6.4 m	7.6 m	8.9 m	10.2 m
<b>Illumination</b>	1 900 lux	1 100 lux	680 lux	470 lux	350 lux	270 lux
<b>Distance</b>	50 ft	65 ft	80 ft	100 ft	115 ft	130 ft
<b>Diameter</b>	12.7 ft	16.5 ft	20.4 ft	25.4 ft	29.3 ft	33.1 ft
<b>Illumination</b>	170 fc	100 fc	70 fc	43 fc	32 fc	25 fc

## Dimensions and weight

### Unit

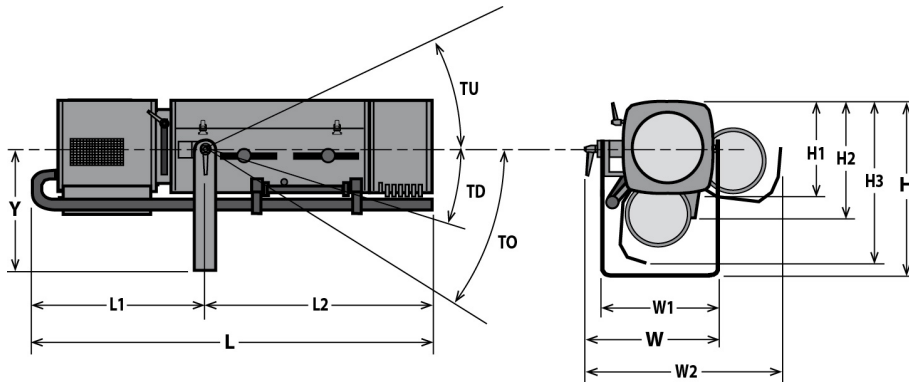

**Weight:** 32 kg (70.4 lbs)

Height	Length	Width	Yoke	Tilt	Option
H= 450 mm (17.7 in)	L= 1190 mm (46.9 in)	W= 410 mm (16.1 in)	Y= 325 mm (12.8 in)	TU= 35°	TO= TBD°
H1= 250 mm (9.8 in)	L1= 500 mm (19.7 in)	W1= 350 mm (13.8 in)		TD= 35°	
H2= 345 mm (13.6 in)	L2= 690 mm (27.2 in)	W2= 570 mm (22.4 in)			
H3= 460 mm (18.1 in)					

### Shipping

- **Weight :** Unit: 37.2 kg (52.8 lbs)  
PSU: 24 kg (52.8 lbs)
- **Volume :** Unit: .26 m<sup>3</sup> (9.18 ft<sup>3</sup>)  
PSU: .04 m<sup>3</sup> (1.41 ft<sup>3</sup>)

### PSU

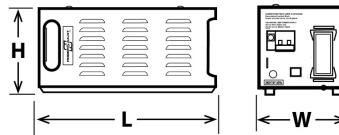

- Width:** W= 185 mm (7.3 in)
- Height:** H= 200 mm (7.9 in)
- Length:** L= 450 mm (17.7 in)
- Weight:** 23 Kg (50.6 lbs)

### Installation

- **Minimum distance to illuminated surface:** 2.8 m ( 9.2 ft )
- **Operating position:**

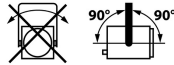

### Warranty

- **Period: 2 years**  
See General Sales Condition on website

### Approvals



### Construction

- **Housing:** Steel sheet - Aluminium
- **Colour:** Black
- **Cooling:** Low noise fan
- **Maximum ambient temperature (Ta):** 40°C (104°F)
- **Maximum case temperature (Tc):** 230°C (446°F)
- **Total heat dissipation:** 5 290 BTU/h
- **Protection rating:** 20

- **PSU housing:** Steel sheet - Aluminium
- **PSU colour:** Black
- **PSU cooling:** Convection cooling
- **PSU maximum ambient temperature (Ta):** 40°C (104°F)
- **PSU maximum case temperature (Tc):** 60°C (140°F)

### Electrical compatibility

- 220/230 V - 50 Hz
- 245 V - 50 Hz
- ~~410/420 V - 60 Hz~~
- 208 V - 60 Hz
- ~~220/230 V - 60 Hz~~
- ~~400 V - 50 Hz~~
- ~~400 V - 60 Hz~~
- Selector: local switch

### Power input



- **Type:** attached power cord
- **Cable:** H07RNF 3G1.5
- **Length:** 3 m (9,8 ft)
- **Power connector:** CEE 7/7 (2P+E NF/Schuko)

### Power consumption

Voltage	Frequency	Current	Power	Power factor
230 V	50 Hz		1550 W	TBD
208 V	60 Hz		1550 W	TBD
245 V	50 Hz		1550 W	TBD

### Power Supply Unit

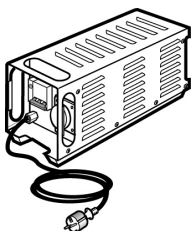







- **PSU:** Separate - Magnetic PSU
- **Lighting unit / PSU cable:** Cable attached to unit - length: 3 m (9,8 ft)  
Type: 3G4 EWKF with 16A black 3P+E 7h IEC60309 connector
- **Maximum distance between lighting unit and PSU:** 25 m (82 ft)
- **Control:** Local
- **Protection:** Mains: 16A 2P2D - C curve breaker / Electronic: 10A 2P2D - C curve breaker









## Model

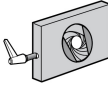

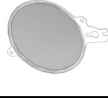

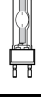





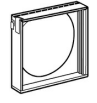

<b>1119</b>	1200 W MSD Followspot - 1119 Topaze - 7/14,5° - Magnetic PSU
-------------	--

## Options

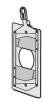
<b>PCP1716A</b>	16A blue 2P+E 6h IEC60309 power connector	
<b>FRO/1117PV</b>	Heavy duty adjustable yoke	
<b>FRO/SMDPV</b>	Heavy duty adjustable yoke equipped with TILT SpotMe sensor (D type)	
<b>PG80</b>	Ø80mm chopper kit (G80+ GR120+ adaptation kit)	
<b>M210TM</b>	6 ways "push/pull" colour changer	
<b>FC1459</b>	Flight-case for Compact range / GT stand / P.S.U. / accessories - Dim: 1340x710x700mm - Weight: 55 Kg	

## Accessories

<b>CCU1</b>	Full closing iris cassette - Weight: 1,33 Kg <b>1 included</b>	
<b>PF1011</b>	Ø210 mm metal filter holder <b>6 included</b>	
<b>SGUP</b>	Universal "A" size gobo-holder (metal, glass, frosted glass) <b>1 included</b>	
<b>VDM100</b>	Ø97mm frosted glass with holder <b>1 included</b>	
<b>M210B</b>	6 ways "boomerang" colour changer - Weight: 3,36 Kg <b>1 included</b>	
<b>MSD 1200W</b>	MSD 1200W - Philips G22 1200W 3000h 6000K lamp	
<b>GT1000</b>	Tripod stand - SWL: 40 Kg - max. height: 1550 mm - Weight: 9,27 Kg	
<b>GT4000</b>	Tripod stand with safety chain - SWL: 130 Kg - max. height: 1030 mm - Weight: 7,91 Kg	
<b>GT4000RSM</b>	Tripod stand with ball head rotation with security chain and SpotMe PAN sensor - SWL: 130 Kg - max. height: 1030 mm	
<b>GT4000S</b>	Tripod stand without safety chain - SWL: 130 Kg - max. height: 1030 mm - Weight: 8,65 Kg	

<b>JPP</b>	Monopod stand for overhead followspot - Weight: 3,6 Kg	
<b>T1000</b>	TV spigot with followspots swivel head - Weight: 1,82 Kg	
<b>T4000</b>	Followspot mount for Ø50mm pipe (suspension or overhead) - SWL= 100 Kg - Weight: 4,88 Kg	
<b>CAV700A</b>	Double slot front cassette for 215x215mm accessories - Weight: ,52 Kg	
<b>FCM100R</b>	Ø97mm 1/2 CTO correction filter (5Rosco #3408) with holder	
<b>VD120</b>	120x120mm frosted glass	
<b>FRO/1017PD</b>	Heavy duty adjustable yoke - Weight: 4,33 Kg	
<b>FRO/SMDPD</b>	Heavy duty adjustable yoke equipped with TILT SpotMe sensor (D type)	
<b>Kit G80</b>	Ø80mm chopper kit (G80+ GR120+ adaptation kit) - Weight: ,69 Kg	
<b>M210T</b>	6 ways "push/pull" colour changer - Weight: 3,67 Kg	
<b>M210TVCL</b>	Light shield for M210T push/pull colour changer - Weight: 1,98 Kg	
<b>Kit TELRAD</b>	Telrad followspot sight with raiser and universal mounting kit - Weight: 1,23 Kg	
<b>SDUP</b>	Followspot cue sheet holder with universal mounting kit	
<b>TCSM</b>	SpotMe calibration tool kit	
<b>SMS</b>	SpotMe server + 2 sensor cables + flight case	
<b>FC1459/S</b>	Flight-case for Compact range / GT stand / P.S.U. / accessories - Weight: 55 Kg	