



Geo
M10

The world's most advanced compact line array

www.nexo-sa.com

Thinking. *Inside the box.*

NEXO



GEO M10

The world's most advanced compact line array



Just 531mm wide and 21Kg in weight, NEXO's extraordinary GEO M10 combines a number of patented technologies with advanced DSP control and integral, 'no loose parts' rigging to create a compact, powerful, wide-bandwidth module that's quick and easy to deploy in flown arrays or groundstacks.

Favouring innovative new thinking over conventional line array wisdom, GEO M10 partners a 1.4" throat / 2.5" titanium diaphragm HF driver with a single, Neodymium-magnet 10" driver and delivers an unprecedented ratio of LF response to cabinet size, outperforming many larger, dual-driver designs. And with a maximum SPL of 136dB, GEO M10 is twice as powerful as its sister-system, the GEO M6, making it ideal for speech and music events with larger audiences.

Two versions of the GEO M10 (offering 12.5° and 25° of vertical dispersion) can be configured manually, without tools, for 80° or 120° horizontal dispersion, and are complemented by the dedicated MSUB15. Extending system response down to 40Hz, the sub can be configured in Omni or Cardioid modes in flown arrays or groundstacks, using a versatile bumper.

GEO M10 and MSUB15 are available in Touring and Installation versions. Cabinets are available in black, white and custom RAL colours, and 'plug and play' amplification and processing comes from NEXO's compact and powerful NXAMP or DTD and DTDAMP.



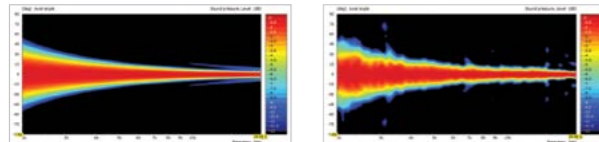
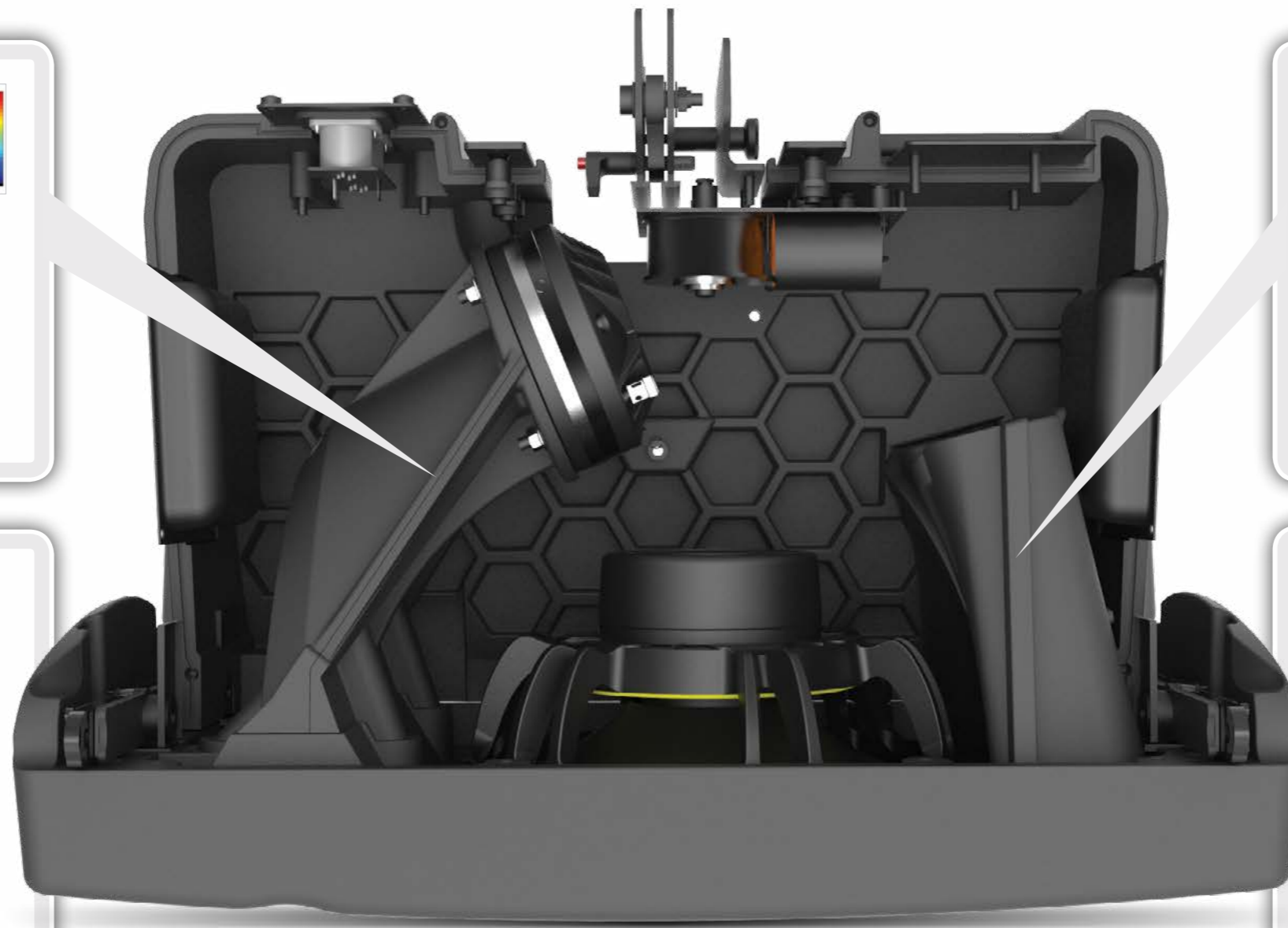

Ideal theoretical response Actual measured response

Patented Hyperbolic Reflective Wavesource

GEO M10 makes full use of NEXO's patented Hyperbolic Reflective Wavesource (HRW™) to control acoustic energy by creating a virtual wavesource 'outside the box', resulting in optimal wavesource coupling without destructive interference.



Patented Port Tube Profiling

Inspired by NEXO's STM M46 cabinet, internal faces of the V-shaped port tube are profiled to ensure smooth air flow, reducing turbulence to increase low frequency efficiency and linearity at high power.



Patented Phase Directivity Device™ (PDD)

A Directivity Phase Device (DPD) on the cone driver extends the upper frequency limit for line source coupling between adjacent speakers. 10" drivers coherently couple as if there were twice as many 5" cones mounted at half the physical distance.

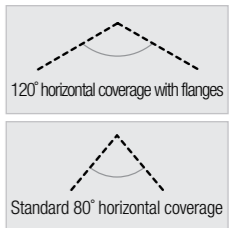
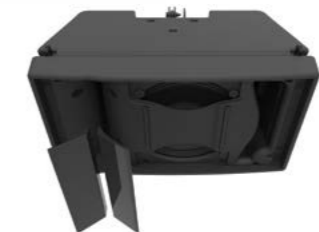

Magnetic Waveguide Flanges

System flexibility can be increased by adding magnetic flanges to the HF waveguide exit, changing the standard 80° acoustic coverage across the horizontal plane to 120°. No tools are required to remove or replace the grille and flanges.

59Hz - 20kHz the smart way

The 2-way passive GEO M10 employs a single 10" driver to deliver the principal benefit of extended LF response over conventional, dual 6" designs. With GEO M10, NEXO has built on its proven expertise in deploying single 10" drivers – the GEO S8 and PS10 being among the world's most successful compact line array and sound reinforcement speakers respectively – to optimise the many advantages of this configuration while removing what may previously have been perceived as drawbacks. The cabinet is injection-moulded from the same urethane co-polymer material used in the groundbreaking STM M28 cabinet. Strong and light in weight, this material is also very

rigid, improving sonic performance. The single-driver design offers better vertical control, with NEXO's proprietary Phase Directivity Device (PDD) extending upper line source coupling frequency limits between the adjacent 10" drivers, so the adjacent loudspeakers couple as coherently as if there were twice as many 5" drivers, mounted at half the physical distance. And the 1.4" titanium diaphragm HF driver employs NEXO's patented Hyperbolic Reflective Wavesource (HRW™) for optimal wavesource coupling.



AutoRig™
Click to deploy



Fly or stack, it's a one-person job

GEO M10 is a system that is as easy for one person to fly as it is to stack, with or without subs. Main cabinets feature convenient handles on the back and sides, while the MSUB15 has handles on each side. All GEO M10 cabinets use an ingenious, TÜV-compliant, AutoRig™ integral rigging system with no external or loose parts. The rigging can held in the 'open'



position, locking closed when the next box is located, making it easy for one pair of hands to configure systems straight out of the flightcases. A total of 9 rigging angles are available which can be set quickly and easily from the rear of the cabinet using a single, integrated ball lock and cable tie, and a guide to hole alignment.



Theatres and Conferences



GEO M10 is a great choice for theatres and conference halls in both mobile and fixed installations. Using the Touring Bumper to fly 2 x MSUB15s with 6 x GEO M1012 per side weighs in at under 250Kg to make a compact system that leaves sight lines unaffected from every seat in the house. Adding 2 x MSUB15s on the floor necessitates a total of 1 x NXAMP4X2_{MK2} per side to power the entire system.



Live Events



GEO M10 groundstacks are the perfect sound reinforcement solution for live events. Quick and easy to deploy, this system uses the Touring Bumper to configure stacks of 2 x MSUB15s with 3 x GEO M1012 cabinets on top. And just one NXAMP4X2_{MK2} is all it takes to power and control a highly-capable stereo system that's equally suitable for speech and music.



Public Spaces



Compact, light in weight and with extended LF response down to 59Hz, GEO M10 makes for a potent yet visually unobtrusive sound reinforcement system in public spaces such as airports and theme parks. These '3 box' arrays use the Light Bumper, and up to 4 (12 boxes in total) can be powered by one NXAMP4X2_{MK2}, networkable over Dante, EtherSound or AES.



Live Music



Larger GEO M10 arrays are ideal for live music events with larger audiences. This system flies both main boxes and subs: 12 x GEO M1012 per side using the Light Bumper and 8 x MSUB15s with the fourth and eighth sub from the top reversed. One NEXO NUAR rack per side provides power for this stereo system.



NXAMP

Plug & play power and processing for GEO M10

Amongst the most flexible amplifiers in the industry, NEXO's NXAMP4X2_{Mk2} combines 4 x 2500 Watts (2 Ohm load) amplification with linear phase processing presets for every NEXO cabinet, making it easy to power systems of any size. A single NXAMP4X2_{Mk2} channel can power up to 3 x GEO M10 modules or up to 2 x MSUB15 cabinets, making it possible to power a substantial groundstacked system or line array from a single amplifier just 2 rack units in height. With optional Dante™,

EtherSound™ and AES cards available, the NXAMP4X2_{Mk2} represents a scalable, networkable and cost-effective integration of command, control, protection and amplification for GEO M10 systems.

Smaller GEO M10 systems can be powered by NEXO's DTD/ DTDAMP and larger systems by the NXAMP4X4.



NS-1 System Configuration Software

Available to download free of charge, NS-1 is a powerful and intuitive system configuration and simulation tool enabling users to configure and optimise the performance of GEO M10 or any NEXO system by predicting its behaviour in any venue to ensure uniform SPL coverage.



NeMo Remote Control app

NeMo is a remote control app for mobile terminals of a set of NEXO NXAMP powered TDControllers. It allows the user to control one or a network of NXAMPs from a Mac, iPad, iPhone or iPod Touch through a Wi-Fi network. Managing and positioning amplifiers, monitoring their parameters (levels, etc.), and setting new values (volume, delay, setup, etc.) are all possible via an attractive and intuitive user interface.

Accessories



Touring Bumper

The Touring Bumper (VNT-BUMPM10) enables mixed GEO M10 and MSUB15 flown arrays or groundstacks and can handle a line of up to 12 main boxes or 8 subs. Including an extension bar for extreme angles, the Touring Bumper supports two industry-standard inclinometer formats.

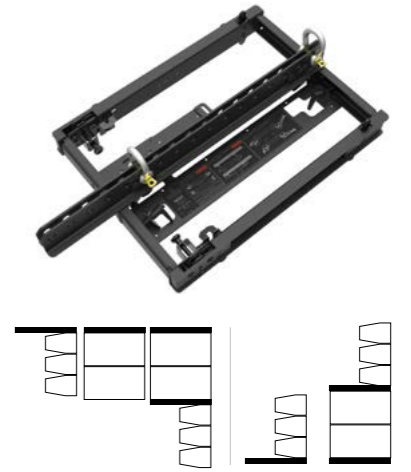

Light Weight Bumper

Perfect for smaller systems, the Touring Bumper (GMT-LBUMPM10) is compatible with the GEO M10 main box only (not MSUB15) and can handle flown arrays of up to 12 boxes. It can also be used to create small groundstacks of up to 3 boxes and an extension bar is also available. The Light Bumper depth is the same as the GEO M10 cabinet depth.

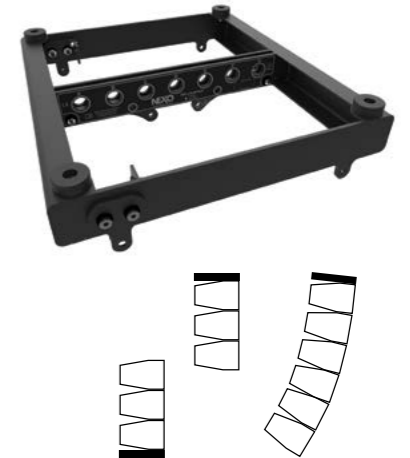

Flightcases

Two GEO M10 wheeled flightcases share the same external dimensions of 598 (w) x 1115 (h) x 918 (d). The first case accommodates 6 x GEO M10 main cabinets and the second, 2 x MSUB15s. A third, smaller case for 3 x GEO M10 main boxes can be opened on both sides, with the HF on the left or right of the array.





Measuring 531mm wide x 288mm high x 355mm deep and weighing 21Kg, the GEO M10 is available in Touring and Installation formats in two versions: GEO M1012 with 12° vertical dispersion and GEOM1025 with 25° vertical dispersion. Both cabinets can be set for 80° or 120° horizontal dispersion using magnetic flanges in the waveguide, with no tools required. Cabinets are constructed from a reticulated urethane co-polymer material and feature integral rigging with no loose parts and handles on the rear and sides. GEO M10 is available in black, white or custom RAL colours.



Specifications

GEO M10 with NEXO TDController setup	
Frequency Response @-6 dB	59 Hz to 20 KHz
Sensitivity 1W @ 1m	100dB SPL Nominal
Nominal Peak SPL @ 1m	136dB
Vertical Dispersion	12° for GeoM1012 25° for GeoM1025
Horizontal Dispersion	80° or 120° Horizontal (adding magnetic CDD)
Crossover Frequencies	LF-HF: 1.3kHz Passive
Nominal Impedance	8Ω
Recommended Power	750W per box

PRODUCT FEATURES	
Components:	LF: 1 x 10" 8Ω long excursion driver HF: 1 x 1.4" throat driver on a BEA/FEA optimised HR Wavesource™
Height x Width x Depth	288mm x 531mm x 355mm
Weight: Net	21kg
Connectors	2 x NL4 Speakon 4 poles (Touring version) 2 x Cable gland with 2 core cables (Installation version)
Construction	Lightweight Polyurethane composite
Fittings:	Handles 4 Side Handles (2 vertical + 2 horizontal) + back grip Front Finish Steel front grille (Touring version) Acoustic Fabric fitted front grille (Installation version)

SYSTEM OPERATION	
Recommended powering solution	NXAMP4X2mk2 Powered TDcontroller: up to 3 x GEO M10 per channel
Optional powering solution	DTD TDcontroller + DTDAMP4x1.3 Power amplifier: up to 2 x GEO M10 per channel NXAMP4X1 Powered TDcontroller: 1 x GEO M10 per channel NXAMP4X1 Powered TDcontroller (Bridged): up to 2 x GEO M10 per channel NXAMP4X4 Powered TDcontroller: up to 4 x GEO M10 per channel
Speaker Cabling	2+/2-

MSUB15

Measuring 434mm wide x 531mm high x 704mm deep and weighing 40Kg, the MSUB15 is the same width as the GEO M10 main cabinet, and 50% higher. Available in Touring and Installation formats, cabinets are constructed from Baltic birch ply with large composite bumpers on the corners, and feature integral rigging. Employing a single 15" diameter / 3" voice coil Neodymium driver in a high-efficiency band pass cabinet design with a quadratic shaped profiled port, the MSUB15 can be deployed in Omni or Cardioid modes and is available in black, white or custom RAL colours.



Specifications

GEO MSUB15 with NEXO TDController setup	
Frequency Response @-6 dB	40 Hz to 120 Hz
Sensitivity 1W @ 1m	101dB SPL Nominal
Nominal Peak SPL @ 1m	136dB
Crossover Frequencies	40-65, 40-75, 40-85, 40-95, 40-120 Hz
Nominal Impedance	8Ω
Recommended Power	900W per box

PRODUCT FEATURES	
Components:	1 x 15" 8Ω long excursion Neodymium driver
Height x Width x Depth	434mm x 531mm x 704mm
Weight: Net	40 kg
Connectors	4 x NL4 Speakon 4 poles (2 front and 2 back, Touring version) 2 x Cable gland with 4 core cables (front or back, Installation version)
Construction	Baltic Birch Ply & textured black or white coating
Fittings:	Handles Side Handles Front Finish Steel front grille (Touring version) Acoustic Fabric fitted front grille (Installation version)

SYSTEM OPERATION	
Recommended powering solution	NXAMP4X2mk2 Powered TDcontroller : up to 2 x MSUB15 per channel NXAMP4X4 Powered TDcontroller : up to 3 x MSUB15 per channel
Optional powering solutions	DTD TDcontroller + DTDAMP4x1.3 Power amplifier: 1 x MSUB15 per channel NXAMP4x1mk2 Powered TDcontroller (Bridged): up to 2 x MSUB15 per channel NXAMP4X4 Powered TDcontroller : up to 3 x MSUB15 per channel
Speaker Cabling	1+/-

GEO M10 System Components

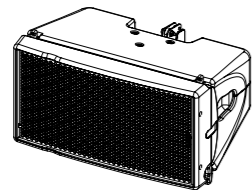

GEO M1012
Line array element, 2 way passive, 1 x 10 inches, touring, black, 12.5° vertical, 80° horizontal, 59 Hz - 20 KHz, 136 dB, 21 Kg (GEO M1012-PW for white version)

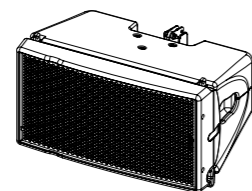

GEO M1025
Line array element, 2 way passive, 1 x 10 inches, touring, black, 25° vertical, 80° horizontal, 59 Hz - 20 KHz, 136 dB, 21 Kg (GEO M1025-PW for white version)

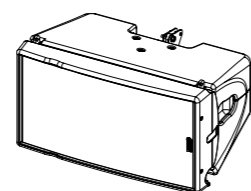

GEO M1012-I
Line array element, 2 way passive, 1 x 10 inches, install, black, 12.5° vertical, 80° horizontal, 59 Hz - 20 KHz, 136 dB, 21 Kg (GEO M1012-IPW for white version)

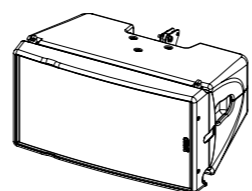

GEO M1025-I
Line array element, 2 way passive, 1 x 10 inches, install, black, 25° vertical, 80° horizontal, 59 Hz - 20 KHz, 136 dB, 21 Kg (GEO M1025-IPW for white version)

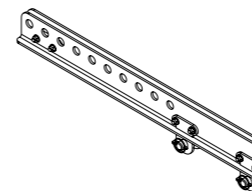

GMT-EXBARM10L
Extension bar for GMT-LBUMP M10, 1 or 2 rigging points, 6.9 Kg

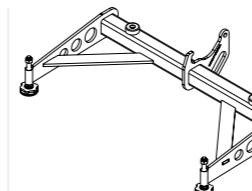

VNT-GSTKM10L
Long stacking extension for VNT-BUMP M10, 9 Kg

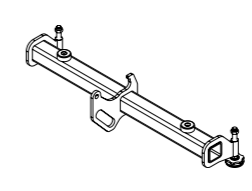

VNT-GSTKM10S
Short stacking extension for VNT-BUMP M10, 6 Kg

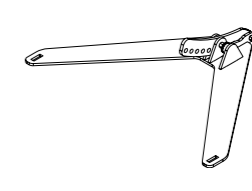

VNT-MNSTKM10
Stacking accessory for GEO M10 on top of MSUB15, 2.2 Kg

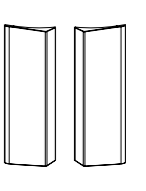

GMT-FLGM10
Pair of magnetic flanges for GEO M10 (all models) for 120° horizontal directivity (GMT-FLGM10-PW for white version)

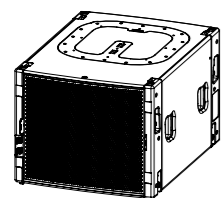

MSUB15
Arrayable Sub band-pass Element, 1 x 15 inches, Touring, black, 40 Hz - 120 Hz, 136 dB, 40 Kg (MSUB15-PW for white version)

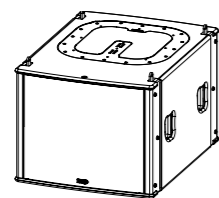

MSUB15-I
Arrayable Sub band-pass Element, 1 x 15 inches, Install, black, 40 Hz - 120 Hz, 136 dB, 40 Kg (MSUB15-IPW for white version)

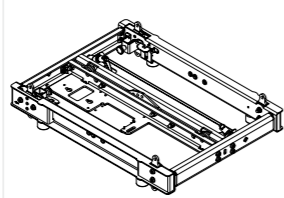

VNT-BUMP M10
Lifting/Stacking bumper for GEO M10 and MSUB15, 2 rigging points, 20 Kg

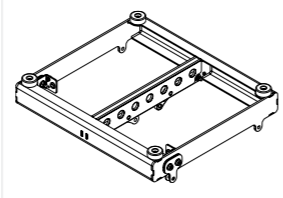

GMT-LBUMP M10
Lifting/Stacking bumper for GEO M10, 1 rigging point, 7.8 Kg

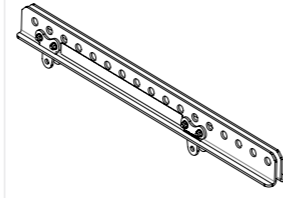

VNT-EXBARM10
Extension bar for VNT-BUMP M10, 1 or 2 rigging points, 8.8 Kg

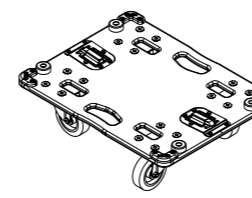

MST-WBMSUB15
Wheel board for MSUB15

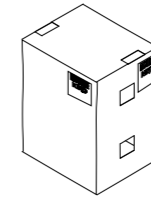

MST-COVMSUB15
Cover for MSUB15

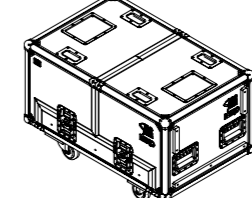

GMT-3CASE M10
Flight case for 3 x GEO M10, both side opening



GMT-6CASE M10
Flight case for 6 x GEO M10

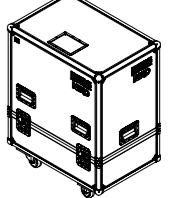

MST-2CASE MSUB15
Flight case for 2 x MSUB15



NEXO S. A.

Parc D'Activité
du Pré de la Dame Jeanne
B.P.5
60128 PLAILLY
France
Tel: +33 (0)3 44 99 00 70
Fax: +33 (0)3 44 99 00 30
E-mail: info@nexo.fr