

SPARX 30

WASHBEAM TWINZOOM

The superstar
for breathtaking
washbeams with
wow effect!

Zoom
3°-70°
(1:23)

Output
36,000
lumen

only
29 dB(A)
extremely
quiet

only
27.3 kg
weight

61 x
40 Watt
LED output

Made in
GERMANY

The Washbeam Sparx30 with TwinZoom – extremely bright, dramatic and quiet!

The Sparx30 LED washlight, with TwinZoom and 61x 40 watt LED power, is an absolute superstar for impressive washlight applications in breathtaking quality and variety.

The optical system guarantees perfectly homogeneous illumination, effective Kling-Net and multicolour applications as well as colour gradients in unimagined variety and brilliance. With the help of the segmentally controllable TwinZoom of 3°–70° (1:23), completely new beam effects and shapes that were previously unthinkable in this form, can be created. The basic color temperature of the Sparx30 is freely selectable enabling it to be ideally integrated into existing lighting ensembles. Thanks to its 61 LEDs, it is in a league of its own when playing media content. With LED single pixel control, color-spreading and sparkle channels as well as its variety of patterns and colours, it also impresses across the board with backlighting. With its low weight (just 27.3 kg) and its compact design, it is ideally suited for use on tour. Special heatpipe cooling enables the Sparx30 to go about its work so quietly it is hard to believe it is possible.

Sparx30 – the superstar for impressive washlight applications, with features such as:

- Patented TwinZoom from 3°–70° (1:23)
- Individual LED single pixel control
- Macro channels for simple effect utilisation
- Overlay of multiple layers with independent patterns
- Glow channel and Color Spread channel
- Sparkle channel for dynamic effects
- Optimised color mixing behaviour
- Flicker-free operation, camera mode up to 600 Hz
- stepless and color-accurate dimming from 0–100%
- Ultra-quiet 29 dB(A)
- Electronic strobe with pulse and random effects
- Separate CTC channel
- Basic colour temperature can be selected:

2700 K

3200 K

4200 K

5600 K

6000 K

6500 K

7000 K

8000 K

100 K steps



DMX



Ethernet



Wifi



Bluetooth

Find more information at: www.jb-lighting.de

SPARX 18 SPECIAL FEATURE: TWINZOOM

With the TwinZoom, the outer LED ring and the inner area can be zoomed separately from each other, infinitely variable from 3°–70° (1:23). This makes it possible to create absolutely innovative, beautifully shaped and effective lighting scenes that you never dared to dream of.



SPARX 30
61x 40Watt RGBW-LED
36,000 lm
CRI > 85



SPARX 30
61x 40Watt RGBY-LED
30,000 lm
CRI > 90

The Sparx30 with RGBW LEDs: Your first choice when you want to focus on **high-intensity cold-white applications**.

Sparx30 with RGBY LEDs (amber): Recommended when primarily **warm-white or orange-colored applications** are required.

STEPLESS ZOOM: 3°–70° (1:23)

The luminosity and zoom range of 3°–70° of the Sparx 30 are impressive. Virtually noiseless, absolutely precise and fast, the Sparx 30 changes from extremely narrow to wide beam distribution. When TwinZoom is used, you can be sure of its wow factor.



Narrow beam with minimal zoom: 3°



Wide beam distribution at a maximum zoom of 70°

HARD EDGE & SOFT EDGE

Thanks to the scattered light-optimised beam of the Sparx 18 and the TwinZoom, precise, extremely homogeneous light projections from Hard Edge to Soft Edge can be produced.

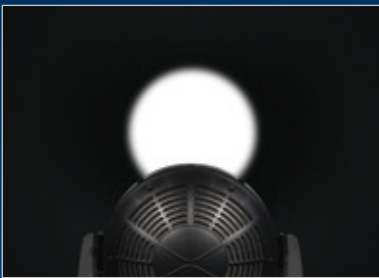

Hard Edge

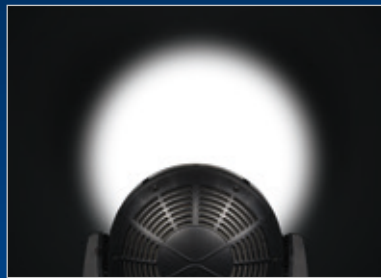

Soft Edge

The Sparx 30 with Beamshape module (optional accessory).

PERFECTLY STAGED: MULTICOLOR BEAMS & GRADIENTS

The Sparx 30 from JB-Lighting is a versatile, high-performance washlight that knows how to make an impressive performance on any stage with its brightness, and its variety of colors and patterns. It is so multifaceted, vivid and versatile that it can hold back discreetly and then skilfully put itself back in the spotlight when the director or scenario permits – whether in the theatre, at trade fairs, events or TV appearances.

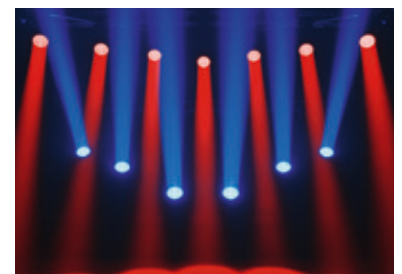



OPTIONAL: HONEYCOMB

Should it be necessary for special uses to further reduce the minimum stray light of the Sparx30 beam, it can be equipped with a honeycomb screen as an optional extra.

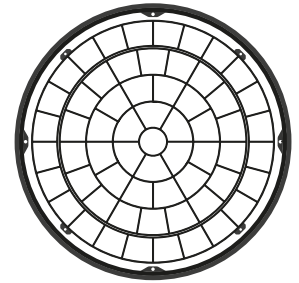

OPTIONAL: BEAMSHAPE MODULE

The continuously rotatable and positionable beam shape creates asymmetrical, oval beams. This beam form is suitable e.g. in the theatre excellent as an aisle light or at trade fairs for the illumination of rectangular objects. Of course, the TwinZoom can also be used in this case to individually adjust the beam width and characteristics. In combination with the endless rotation of the Beamshape module, extremely dynamic, circular animation effects can also be achieved.

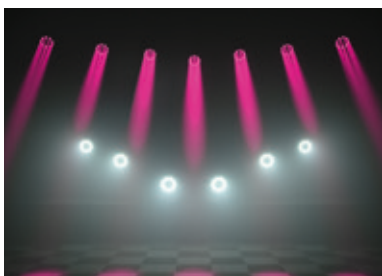
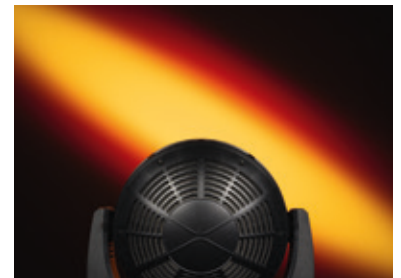
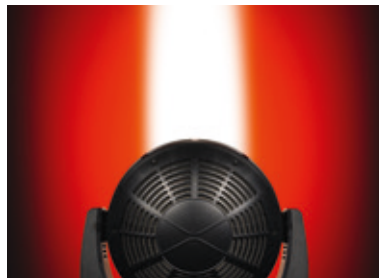

BEAM AND SHOW EFFECTS OF THE HIGHEST QUALITY

The Sparx 30 immediately wends its way into the hearts of the audience with its impressive stage performance. 61 LEDs, single pixel control, TwinZoom and sparkle effect, perfect dimming characteristics and optimised color blending behaviour make it the absolute darling of the public that knows no compromise. And as befits a perfect entertainer, it also has further effective additions to its programme with separate CTC, Glow channel and Color spread channel.

Technical specifications:

Optics and light source

- 61 RGBW high-performance LEDs of 40 W each
Standard: RGBW-LED; 36,000 lm; CRI > 85
Optional: RGBY-LED; 30,000 lm; CRI > 90
- > 20.000 h life time
- Flicker-free operation, camera mode up to 600 Hz
- TwinZoom system: Zoom range 3°–70° (1:23)
- Highly efficient optics for perfect color mixing

Effects

- Individual LED control – Single pixel control
- Sparkle channel for dynamic effects
- Multiple layers with independent patterns can be stacked on top of each other
- Macro channels for simple utilisation of effects
- Countless color and pattern combinations
- Glow channel and Color spread channel as additional color effects
- Separate CTC channel
- Optimised color mixing behaviour
- High-resolution, steplessly variable dimmer 0–100%
- Color-accurate dimming
- Electronic strobe with pulse and random effects
- TwinZoom effects: Multicolor beams and innovative beam shapes
- Basic color temperature can be selected: 2700 K, 3200 K, 4200 K, 5600 K, 6000 K, 6500 K, 7000 K or 8000 K + variable in 100 K steps

Movement

- 3 phase extra strong stepping motors
- Precise, very fast and silent movement
- 540° pan / 330° tilt

Control and programming

- USITT DMX-512, RDM
- Ethernet interface with Art-Net, sACN and Kling-Net
- Wireless DMX / RDM Lumen Radio CRMx TiMo
- Bluetooth, Wifi
- Color touch display with function keys and battery backup
- Mini USB for software update
- Stand-alone mode, master/slave function
- Built-in DMX analyser

Construction

- Robust, roadworthy design
- Individually changeable LEDs
- Fan control for almost noiseless operation, 29 dB(A)
- Graphical display, electronically revolvable
- Neutrik 5pin XLR IN/OUT
- Neutrik etherCON RJ45 IN/OUT
- Neutrik powerCON TRUE1 IN/OUT

Rigging

- 2 Omega brackets with Original Camloc® fasteners for quick and convenient installation in any position, with four different fastening options

Electrical specification

- Max. power consumption 2200 VA
- Input voltage range 100V–240V, 50/60 Hz

Mechanical specifications

- Dimensions: B 530 x D 308 x H 628 mm
- Weight: 27,3 kg

Dimensions:

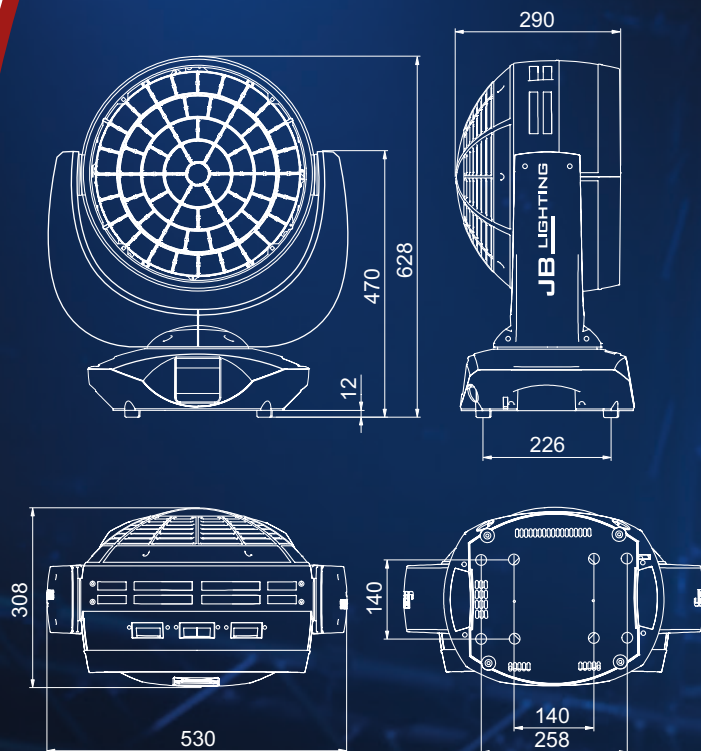

Accessories:

- **Beamshape module** (Code ZU0019)
- **Honeycomb** (Code ZU0021)
- **AMPTOWN single** with SiP foam inlet (Code CASE36)
Dimensions: B 60 x D 60 x H 84 cm
Weight without (incl. fixtures): approx. 43 (70) kg
- **AMPTOWN double** with SiP foam inlet (Code CASE37)
Dimensions: B 120 x D 60 x H 84 cm
Weight without (incl. fixtures): approx. 62 (117) kg



All technical specifications are subject to change without notification © JB-Lighting 6.2019

JB LIGHTING

JB-Lighting Lichtenlagentechnik GmbH · Sallersteig 15 · D-89134 Blaustein
Tel. +49 (0)7304 9617-0 · E-Mail: info@jb-lighting.de
www.jb-lighting.de