



SolaWash 19 LED

SolaWash 19 LED

User Manual

© High End Systems Inc., 2017, All Rights Reserved

Information and specifications in this document are subject to change without notice. High End Systems assumes no responsibility or liability for any errors or inaccuracies that may appear in this manual.

Trademarks used in this text:

High End Systems is a registered trademark. Wholehog, intellaspot, Internal Effects, the High End Systems globe logo, and the Hog logo are trademarks of High End Systems, Belden is a registered trademark of Belden, Inc.

Other trademarks and trade names may be used in this document to refer to either the entities claiming the marks and names or their products. High End Systems disclaims any proprietary interest in trademarks and trade names owned by others.

HIGH END SYSTEMS



an ETC. Company

SolaWash 19 LED User Manual

Version 1.0.2

July, 2015

Contact Information

U.S. and the Americas

Sales Department High End Systems
2105 Gracy Farms Lane
Austin, TX 78758 USA
voice: 512.836.2242
fax: 512.837.5290
Toll Free: 800.890.8989

Customer Service High End Systems
2105 Gracy Farms Lane
Austin, TX 78758 USA
voice: 800.890.8989
fax: 512.834.9195
toll free: 800.890.8989

World Wide Web: <http://www.highend.com>

Product Modification Warning

High End Systems products are designed and manufactured to meet the requirements of United States and International safety regulations. Modifications to the product could affect safety and render the product non-compliant to relevant safety standards.

Mise En Garde Contre La Modification Du Produit

Les produits High End Systems sont conçus et fabriqués conformément aux exigences des règlements internationaux de sécurité. Toute modification du produit peut entraîner sa non conformité aux normes de sécurité en vigueur.

Produktmodifikationswarnung

Design und Herstellung von High End Systems entsprechen den Anforderungen der U.S. Amerikanischen und internationalen Sicherheitsvorschriften. Abänderungen dieses Produktes können dessen Sicherheit beeinträchtigen und unter Umständen gegen die diesbezüglichen Sicherheitsnormen verstoßen.

Avvertenza Sulla Modifica Del Prodotto

I prodotti di High End Systems sono stati progettati e fabbricati per soddisfare i requisiti delle normative di sicurezza statunitensi ed internazionali. Qualsiasi modifica al prodotto potrebbe pregiudicare la sicurezza e rendere il prodotto non conforme agli standard di sicurezza pertinenti.

Advertencia De Modificación Del Producto

Los productos de High End Systems están diseñados y fabricados para cumplir los requisitos de las reglamentaciones de seguridad de los Estados Unidos e internacionales. Las modificaciones al producto podrían afectar la seguridad y dejar al producto fuera de conformidad con las normas de seguridad relevantes.

Important Safety Information

Instructions pertaining to continued protection against fire, electric shock, and injury to persons are found throughout this manual. Please read all instructions prior to assembling, mounting, and operating this equipment.

The following international caution and warning symbols appear in margins throughout this manual to highlight messages.



This symbol appears adjacent to Caution messages. Not heeding these messages could result in personal injury and/or damage to equipment.



This symbol appears adjacent to high voltage warning messages. Not heeding these messages could result in serious personal injury.



This symbol cautions against mounting the fixture on or near a flammable surface.



This symbol indicates that, while operating, equipment surfaces may reach very high temperatures. Allow the fixture to cool before handling.

Warranty Information

Limited Warranty

Unless otherwise stated, your product is covered by a one year parts and labor limited warranty. Dichroic filters and LithoPatterns® high resolution glass gobos are not guaranteed against breakage or scratches to coating. It is the owner's responsibility to furnish receipts or invoices for verification of purchase, date, and dealer or distributor. If purchase date cannot be provided, date of manufacture will be used to determine warranty period.

Returning an Item Under Warranty for Repair

It is necessary to obtain a Return Material Authorization (RMA) number from your dealer or point of purchase BEFORE any units are returned for repair. The manufacturer will make the final determination as to whether or not the unit is covered by warranty.

A fixture must be returned in its original packaging. Any other parts returned to High End Systems must be packaged in a suitable manner to ensure the protection of such product unit or parts, and such package shall be clearly and prominently marked to indicate that the package contains returned Product units or parts and with an RMA number. Accompany all returned Product units or parts with a written explanation of the alleged problem or malfunction. Ship returned Product units or parts to: 2105 Gracy Farms Lane, Austin, TX 78758 USA.

Note: *Freight Damage Claims are invalid for fixtures shipped in non-factory boxes and packing materials.*

Freight

All shipping will be paid by the purchaser. Items under warranty shall have return shipping paid by the manufacturer only in the Continental United States. Under no circumstances will freight collect shipments be accepted. Prepaid shipping does not include rush expediting such as air freight. Air freight can be sent customer collect in the Continental United States.

REPAIR OR REPLACEMENT AS PROVIDED FOR UNDER THIS WARRANTY IS THE EXCLUSIVE REMEDY OF THE CONSUMER. HIGH END SYSTEMS, INC. MAKES NO WARRANTIES, EXPRESS OR IMPLIED, WITH RESPECT TO ANY PRODUCT, AND HIGH END SPECIFICALLY DISCLAIMS ANY WARRANTY OF MERCHANTABILITY OR FITNESS FOR A PARTICULAR PURPOSE. HIGH END SHALL NOT BE LIABLE FOR ANY INDIRECT, INCIDENTAL OR CONSEQUENTIAL DAMAGE, INCLUDING LOST PROFITS, SUSTAINED OR INCURRED IN CONNECTION WITH ANY PRODUCT OR CAUSED BY PRODUCT DEFECTS OR THE PARTIAL OR TOTAL FAILURE OF ANY PRODUCT REGARDLESS OF THE FORM OF ACTION, WHETHER IN CONTRACT, TORT (INCLUDING NEGLIGENCE), STRICT LIABILITY OR OTHERWISE, AND WHETHER OR NOT SUCH DAMAGE WAS FORESEEN OR UNFORESEEN.

Warranty is void if the product is misused, damaged, modified in any way, or for unauthorized repairs or parts. This warranty gives you specific legal rights, and you may also have other rights which vary from state to state.

Patents

This product may use one or more of the following patents: US 4,392,187; US 4,602,321; US 4,688,161; US 4,701,833; US 4,709,311; US 4,779,176; US 4,800,474; US 4,962,687; US 4,972,306; US 4,980,806; US 5,010,459; US 5,031,078; US 5,073,847; US 5,078,039; US 5,186,536; US 5,209,560; US 5,278,742; US 5,282,121; US 5,307,295; US 5,329,431; US 5,331,822; US 5,367,444; US 5,402,326; US 5,414,328; US 5,426,576; US 5,430,629; US 5,432,691; US 5,454,477; US 5,455,748; US 5,502,627; US 5,506,762; US 5,515,254; US 5,537,303; US 5,545,951; US 5,588,021; US 5,590,954; US 5,590,955; US 5,640,061; US 5,647,662; US 5,691,886; US 5,702,082; US 5,728,994; US 5,758,955; US 5,758,956; US 5,769,527; US 5,769,531; US 5,774,273; US 5,788,365; US 5,794,881; US 5,795,058; US 5,798,619; US 5,806,951; US 5,812,596; US 5,823,661; US 5,825,548; US 5,828,485; US 5,829,868; US 5,857,768; US 5,882,107; US 5,921,659; US 5,934,794; US 5,940,204; US 5,945,786; US 5,953,151; US 5,953,152; US 5,969,485; US 5,980,066; US 5,983,280; US 5,984,248; US 5,986,201; US 6,011,662; US 6,029,122; US 6,048,080; US 6,048,081; US 6,054,816; US 6,057,958; US 6,062,706; US 6,079,853; US 6,126,288; US 6,142,652; US 6,142,653; US 6,172,822; US 6,175,771; US 6,188,933; US 6,208,087; US 6,219,093; US 6,220,730; US 6,241,366; US 6,249,091; US 6,255,787; US 6,256,136; US 6,261,636; US 6,278,542; US 6,278,545; US 6,278,563; US 6,288,828; US 6,326,741; US 6,327,103; US 6,331,756; US 6,346,783; US 6,421,165; US 6,430,934; US 6,459,217; US 6,466,357; US 6,502,961; US 6,515,435; US 6,523,353; US 6,536,922; US 6,538,797; US 6,545,586; US 6,549,324; US 6,549,326; US 6,563,520; US 6,565,941; US 6,570,348; US 6,575,577; US 6,578,991; US 6,588,944; US 6,592,480; US 6,597,132; US 6,600,270; US 6,601,974; US 6,605,907; US 6,617,792; US 6,621,239; US 6,622,053; US 6,635,999; US 6,648,286; US 6,664,745; US 6,682,031; US 6,693,392; US 6,696,101; US 6,719,433; US 6,736,528; US 6,771,411; US 6,775,991; US 6,783,251; US 6,801,353; US 6,812,653; US 6,823,119; US 6,865,008; US 6,866,390; US 6,866,402; US 6,866,451; US 6,869,193; US 6,891,656; US 6,894,443; US 6,919,916; US 6,930,456; US 6,934,071; US 6,937,338; US 6,955,435; US 6,969,960; US 6,971,764; US 6,982,529; US 6,988,805; US 6,988,807; US 6,988,817; US 7,000,417; US 7,011,429; US 7,018,047; US 7,020,370; US 7,033,028; US 7,048,838; US 7,055,963; US 7,055,964; US 7,057,797; US 7,073,910; US 7,078,869; US 7,092,098; US 7,119,902; US 7,161,562; US 7,175,317; US 7,181,112; US 7,206,023; US 7,210,798; US D347,113; US D350,408; US D359,574; US D360,404; US D365,165; US D366,712; US D370,080; US D372,550; US D374,439; US D377,338; US D381,740; US D409,771; AT E169413; CA 2142619; CA 2145508; CA 2245842; DE 22588.4-08; DE 621495; DE 655144; DE 69320175.4; DE 69322401.0; DE 69331145.2; DE 69525856.7; DE 69734744.3; DE 797503; DK 0655144; DK 1447702; EP 0475082; EP 0621495; EP 0655144; EP 0662275; EP 0767398; EP 0797503; EP 0969247; EP 1447702; ES 0621495; FR 0621495; FR 0655144; FR 0662275; FR 1447702; GB 2043769B; GB 2055842B; GB 2283808B; GB 2290134B; GB 2291814B; GB 2292530B; GB 2292896B; GB 2294909B; GB 2295058B; GB 2303203B; GB 2306887B; GB 2307036B; GB 2316477B; IE 0621495; IT 034244BE; 2005; IT 0621495; IT 0655144; JP 3495373; JP 3793577; NL 0621495; NL 0797503; NL 0969247; UK 0621495; UK 0655144; UK 0662275; UK 0797503; UK 0969247; UK 1447702;

Table of Contents

SolaWash 19 LED User Manual	i
Contact Information	ii
Product Modification Warning	iii
Important Safety Information	iv
Warranty Information	v
Limited Warranty	v
Returning an Item Under Warranty for Repair	v
Freight	v
Patents	vi

Chapter 1: Product Overview

This chapter describes the features and specifications of the SolaWash 19 LED fixture along with a list of related products and accessories.

Features	1
Operation	1
Effects	2
Construction	2
Specifications	3
Mechanical Specifications	3
Electrical Specifications	4
Environmental Specifications	4
Cables and Connectors	4
Fixture Components	5
Related Products and Accessories	6

Chapter 2: SolaWash 19 LED Setup and Configuration

Installation of your SolaWash 19 LED fixture includes mounting, connecting to power, DMX linking and configuration.

Unpacking the Fixture	7
Installing a Power Cord Cap	8
Installing a Line Cord Cap - U.K. Only	8
Vatic Fitter Heads Information - Denmark	8
Mounting the Fixture	9
Mounting the Fixture Upright	9
Truss Mounting	9

Linking SolaWash 19 LED Fixtures	11
Cable Connectors	11
Connecting to the Link	12
Configuring SolaWash 19 LED for DMX Control	13
Setting a Start Channel in Battery Mode	14
Powering On the Fixture	15
Shutting Down the Fixture	15

Chapter 3: Menu System

This chapter shows you how to access and navigate the onboard Menu system and the options available for each menu with examples.

Menu System Overview	17
Navigation Basics	18
Battery Operation	18
Exiting Battery Mode.....	18
SolaWash 19 LED Menu Map	19
Menu System Options	22
Address Menu	22
Setting a Start Channel.....	22
Determining DMX Start Channel Assignment	23
Information Menu	24
Time Info	24
Values Display	25
Head Temperature.....	25
Software Version.....	25
Set Menu	26
Status Options	26
Service Setting	27
Display Setting	28
Temp C/F	28
Reset Default.....	28
Test Options Menu	29
Homing the Fixture.....	29
Calibration.....	29
User Mode Menu	30
Preset Menu	31
Battery Menu	31

Chapter 4: Preset Programming

SolaWash 19 LED fixtures can be programmed through the onboard menu system using Preset Programming. This section describes how to program your fixtures for stand-alone operation using the on-board memory in each fixture to create and store scenes.

Preset Programming Overview	33
Navigating to the Preset Menu	33
Master and Slave	34
Preset Menu	35
Playback Settings	35
Automatic Program Run	35
Set to Slave	35
DMX Control	35
Music Control	35
Edit Scenes	36
Edit Scene Parameters	36
Edit Scene Time	36
Set Fade Time	36
Set Input by Out	37
Edit Program	37
Select Program	38
Scenes Input	38

Chapter 5: DMX Programming

Multiple DMX protocol options let you program SolaWash 19 LED fixtures as a general wash light or with added pixel and pattern control. This chapter describes DMX programming options and SolaWash 19 LED DMX parameters.

DMX Programming Overview	39
Full Speed versus MSpeed Control	39
16-bit Functionality	39
DMX Programming Options	39
Programming with a DMX Console	39
SolaWash 19 LED DMX Protocol Options	40
Standard Protocol	40
Zones Protocol	41
Reduced Protocol	41
Mapping Protocol	42

Parameter Descriptions	43
Color Correction Parameter	43
Color Mixing Parameters	43
Standard and Reduced Protocol Color Function Options.....	43
Zones Protocol Color Function	44
Control Parameter	45
Dim Parameter	45
Image Parameters	46
Indigo Highlighter Parameters	46
MSpeed (Motor Speed)	47
Pan and Tilt Parameters	47
Strobe Parameter	47
Zoom Parameter	48
Chapter 6: General Maintenance and Troubleshooting	
<i>This chapter outlines safety and maintenance procedures as well as</i>	
<i>troubleshooting error messages.</i>	
Safety Considerations	49
Maintenance	49
Troubleshooting Error Messages	49
PAN- movement Er	49
TILT- movement Er	50
Appendix A: MSpeed Conversion Table.....	52

Chapter 1:

Product Overview

This chapter describes the features and specifications of the SolaWash 19 LED fixture along with a list of related products and accessories.

SolaWash 19 LED and SolaWash 37 LED are high brightness moving wash light components of the High End Systems LED line of fixtures.

The SolaWash 19 LED features nineteen 15-watt RGBW LEDs. Sixteen Indigo Highlighter LEDs add another ring of color with independent control. As with all the LED fixtures, the SolaWash 19 offers extremely long life of and low power consumption with no color degradation. A Color Temperature control channel allows you to match the SolaWash output to other conventional light fixtures for a given show.

Multiple user options provide a wide range of DMX control from basic color mixing and “lenses” to controlling color of in different pattern zones or independent color control for each individual LED “pixel”.

Operational features include smooth 16-bit Pan and Tilt, fast zoom control from 12 to 65 degrees with tight beam control and excellent definition, and a full color LCD graphic display with touch control.

Features

- Nineteen 15-watt RGBW LEDs
- Sixteen Indigo Highlighter LEDs
- 100,000 LED component life
- 9000 lumen output
- Rechargeable battery backup for display

Operation

- Pan range: 540° with optional 630°
- Tilt range: 265°
- Red, Green, Blue and White color mixing control
- Onboard menu system for configuration and preset programming
- Linear Zoom: 12°-65°
- Dimmer intensity from 0% to 100%
- General dimming and blackout for individual colors (Red, Green, Blue and White)

- Seven user-programmable factory defined macros
- Four User modes for DMX control
 - Standard (21 channels)
 - Reduced (19 channels)
 - Zones (31 channels)
 - Mapping (90 channels)

Effects

- LED Strobe with 18 flashes per second and pulse effect
- Image lenses and dynamic patterns with speed control (Standard user mode)
- Independent color mixing control for individual zones in 32 pre-programmed patterns (Zones user mode)
- Independent color mixing control for each LED (Mapping user mode)
- Virtual CTO on White

Construction

- High resolution micro-stepping motor control for smooth motion at all speeds
- Fast, smooth, and quiet yoke movement
- Color LCD menu with battery operation
- 3-pin and 5-pin XLR/RDM connectors
- Dual Road Case included
- ETL/UL and CE compliance

Specifications

Mechanical Specifications

Fixture Dimensions: 390 mm x 320 mm x 464 mm (15.4 in x 12.6 in x 18.3 in)

Roadcase Dimensions: 875 mm x 600 mm x 780 mm (34.4 in x 24 in x 31 in)

Fixture Weight: 15.5 kg (34.2 lbs)

Shipping Weight: 78.9 kg (174 lbs)

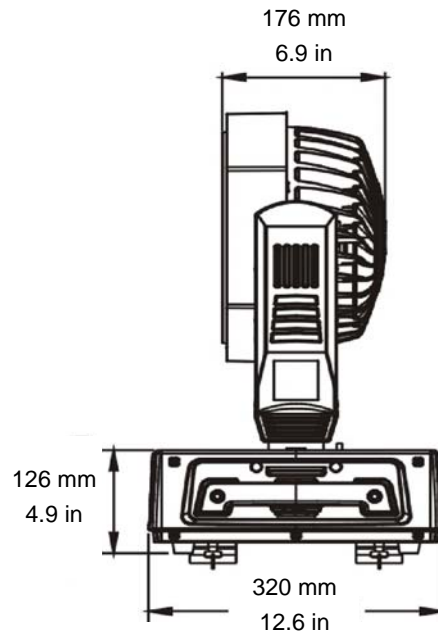
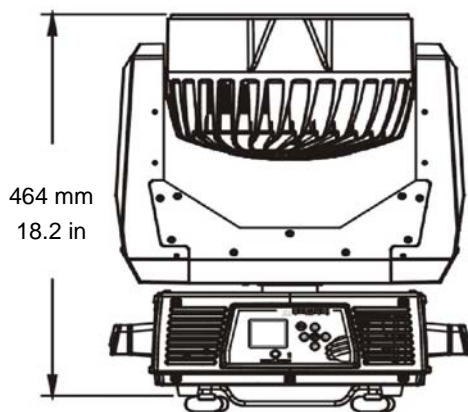
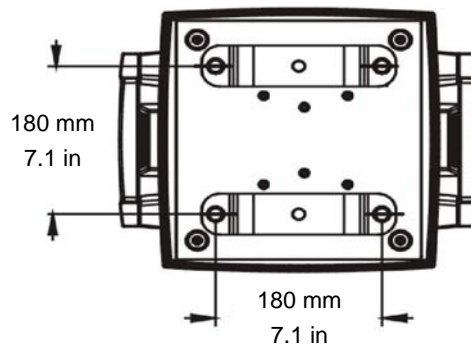
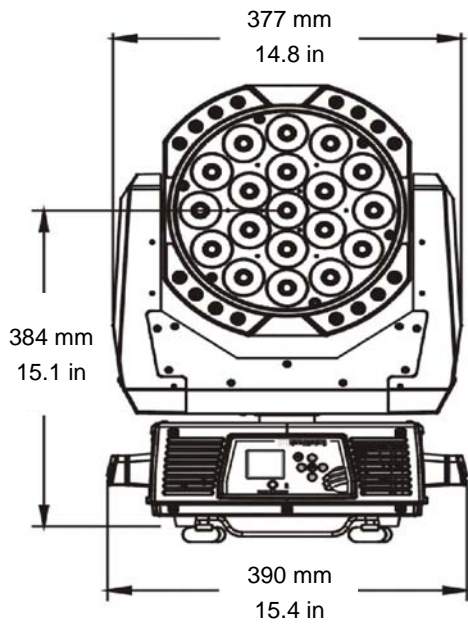

Electrical Specifications

Fixture Rated Power: 380 W

Power consumption: AC 100V–240V; 50Hz/60Hz; 3.8-1.6A



Warning: Class I equipment - For continued protection against electric shock connect this equipment to an earthed (grounded) power source only.

This equipment for connection to branch circuit having a maximum overload protection of 20 A.

Environmental Specifications

Maximum ambient temperature: 45° C (113° F)

Maximum exterior surface temperature: 110° C (230° F)

Minimum distance to lighted object: .5 m (1.6 ft)

Minimum distance to flammable objects: .5 m (1.6 ft)



**Caution: Do not mount on a flammable surface.
Not for residential use.
Use in dry locations only.**



Caution: Class 2 LED product. LED Radiation. Do not stare into beam.

Caution: The fixture should be positioned so that prolonged staring into the fixture at a distance closer than 3 meters is not expected.



Cables and Connectors

Belden® 3107A or equivalent (meets specifications for EIA RS-485 applications) with the following characteristics:

- Two twisted pairs plus a shield
- maximum capacitance between conductors - 30 pF/ft.
- maximum capacitance between conductor and shield - 55 pF/ft.
- maximum resistance of 20Ω / 1000 ft.
- nominal impedance 100-140 Ω

Fixture Components

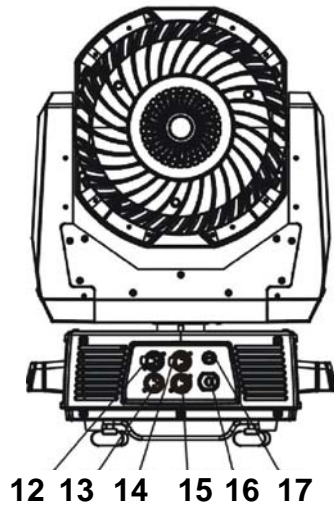
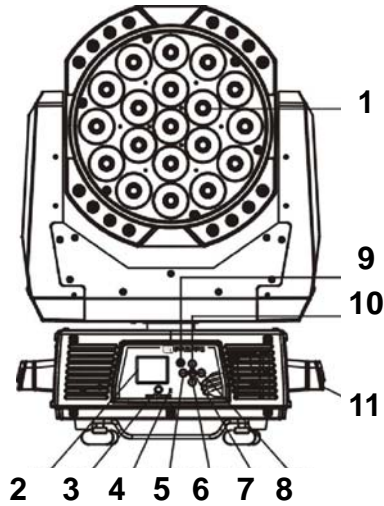

1. Lens
2. Display
3. DC Switch
4. Microphone
5. Left-button
6. Down-button
7. ENTER-button
8. Right-button
9. Mode/Esc
10. Up-button
11. Handle
12. 5-pin DMX out
13. 5-pin DMX in
14. 3-pin DMX out
15. 3-pin DMX in
16. Power supply
17. Fuse

Related Products and Accessories

Name	Part Number
Heavy duty 5-pin XLR cable (10')	55050017
Heavy duty 5-pin XLR cable (25')	55050018
Heavy duty 5-pin XLR cable (50')	55050019
Heavy duty 5-pin XLR cable (100')	55050020
Galvanized safety cable	12040001

Chapter 2: SolaWash 19 LED

Setup and Configuration

Installation of your SolaWash 19 LED fixture includes mounting, connecting to power, DMX linking and configuration.

Use the following steps to set up and configure your fixture:

1. **Unpack the fixture.**
2. **Install power cord cap for your location.**
3. **Mount the fixture upright or suspended from a standard truss.**
4. **Connect the fixture to a DMX controller via DMX cabling.**
5. **Configure the fixture for DMX control.**

Unpacking the Fixture

The SolaWash 19 LED fixture ships in packaging specifically designed to protect the product during transport. When unpacking, inspect the fixture for physical damage to components. High End Systems® assumes no responsibility for products that are damaged during transport. Return a product for repair in its original packaging.

Before sending anything to the factory, call your High End Systems dealer/distributor for a Return Material Authorization (RMA) number. The factory cannot accept any goods shipped without an RMA number.

Installing a Power Cord Cap

The power cord for SolaWash 19 LED fixtures ships without a power cord cap. Use the information in this section to install the correct power cord cap for your location.

Because of the variety of power cord caps used worldwide, High End Systems, Inc. cannot make specific recommendations for the power cord cap. Contact a local authority for the type of power cord cap needed. When installing the power cord cap, note that the cores in the mains lead are colored according to the following code:

- green and yellow = earth
- white = neutral
- black = live

Installing a Line Cord Cap - U.K. Only

In the United Kingdom, core colours in the mains lead of this equipment may not correspond with the colored markings identifying the terminals in the fixture's plug. In that case, install a line cord cap in accordance with the following code:

- Connect the green and yellow core to the plug terminal marked with the letter "E," or by the earth symbol  or coloured green, or green and yellow.
- Connect the white core to the terminal marked with the letter "N" or coloured black.
- Connect the black core to the terminal marked with the letter "L" or coloured red.



WARNING:
Class 1 equipment - This equipment must be earthed.

Vatic Fitter Heads Information - Danmark

Advarsel: Beskyttelse mod elektrisk chock.

Vigtigt!

Lederne med gul/groen isolation maa kun tilsluttes en klemme maerket



eller



Mounting the Fixture

A SolaWash 19 LED fixture can be side-mounted or suspended from a support system (such as a truss) or freestanding on its base.

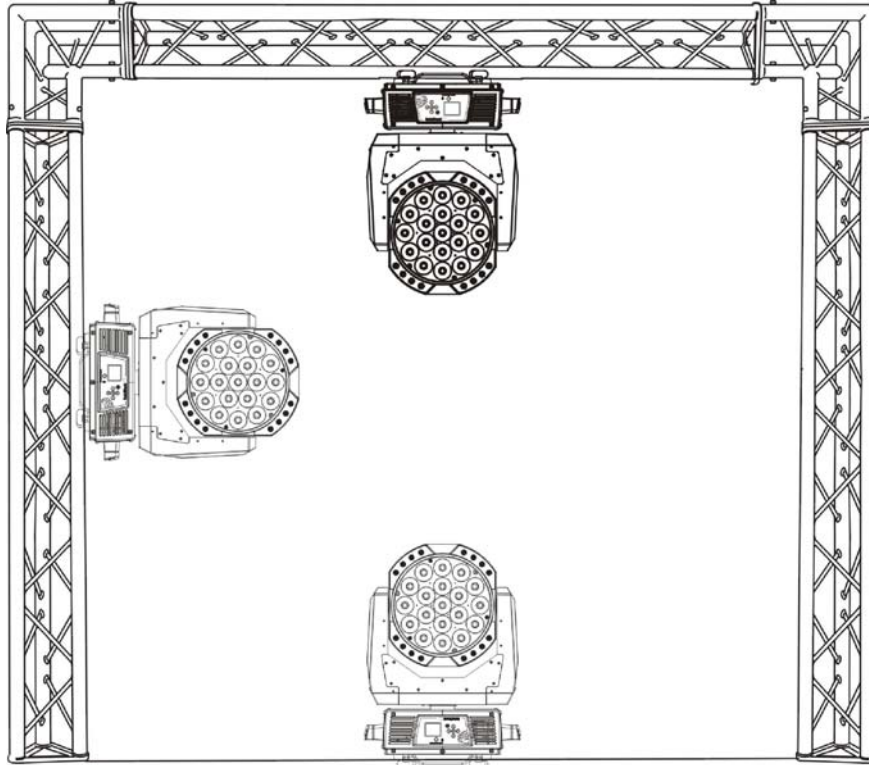

WARNING!

Equipment suitable for dry locations only. Do not expose this equipment to rain or moisture.



CAUTION!

SolaWash 19 LED fixtures must be installed and operated by trained personnel only.

Always use a secondary safety cable when mounting this fixture.

Ambient temperature for this fixture is -10°C to 45°C . In extreme temperature environments, ensure that the fixture is within a safe operating temperature range before turning on to avoid condensation damage.



Do not mount within .5 meters (1.6 feet) of a flammable object.

Note: Due to the wide variety of possible lighting designs, High End Systems cannot make specific mounting recommendations. Consider the following procedures as suggested guidelines only.

Mounting the Fixture Upright



CAUTION!
Do not mount the fixture upright without the four rubber feet attached.

To mount the fixture upright, place the fixture on a sturdy, stable non-flammable surface that will support more than the 15.5 kg (34.2 lb) weight of the SolaWash 19 LED fixture. If the surface is above floor height, use safety cables to secure the fixture to the surface.

Truss Mounting

When mounting the fixture on a truss or another type of support:

- Verify the truss or support will handle the combined weight of all the devices on the truss. Each SolaWash 19 LED fixture weighs 15.5 kg (34.2 lb).
- Always mount a SolaWash 19 LED fixture using the mounting bracket assembly that shipped with your fixture and a safety cable attached to the fixture's base.



WARNING!
Before mounting, disconnect power to the fixture.



CAUTION!
Only experienced lighting personnel should attempt to hang a lighting fixture to an appropriate theatrical truss.



WARNING!
In all cases a safety cable should also be fixed between the safety cable mounting holes located at the bottom of the fixture base housing and the truss. Failure to use a safety cable could result in injury or death. High End Systems supplies the proper safety cables and may be contacted for replacements if necessary. For more information go to: www.highend.com/trusshang

To mount a SolaWash 19 LED fixture on a standard truss:

1. Fix the clamp (A) on the bracket by tightening the M12 screw on the bracket to the hole in the center of the bracket.
2. Insert the quick-lock fasteners (B) of the first Omega holder (C) into the respective holes on the bottom of the fixture. Tighten the quick-lock fasteners fully clockwise.
3. Install the second Omega holder.
4. Secure the fixture to the truss with a safety cable at attach point (D).

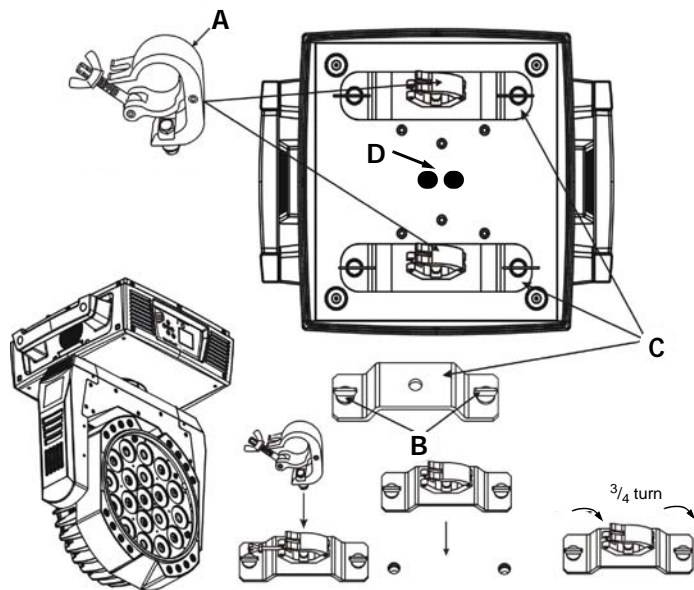

Linking SolaWash 19 LED Fixtures

The SolaWash 19 LED fixture operates on standard DMX512 link controlled by a DMX console. The number of fixtures on a link will be determined by the combined number of channels required by all the fixtures. A SolaWash 19 LED fixture in Standard User mode requires a 21 channel footprint on a standard DMX512 link.

Attach the fixture to the link using data-grade cable and 5-pin or 3-pin XLR cable connectors.

Cable Connectors

The SolaWash 19 LED fixture accepts both 3-pin and 5-pin XLR cable connectors. Cabling must have a male XLR connector on one end of the cable and a female XLR connector on the other end.

Note: Pins four and five of a 5-pin cable connector are not used, but they allow a secondary data link to pass through the fixture.

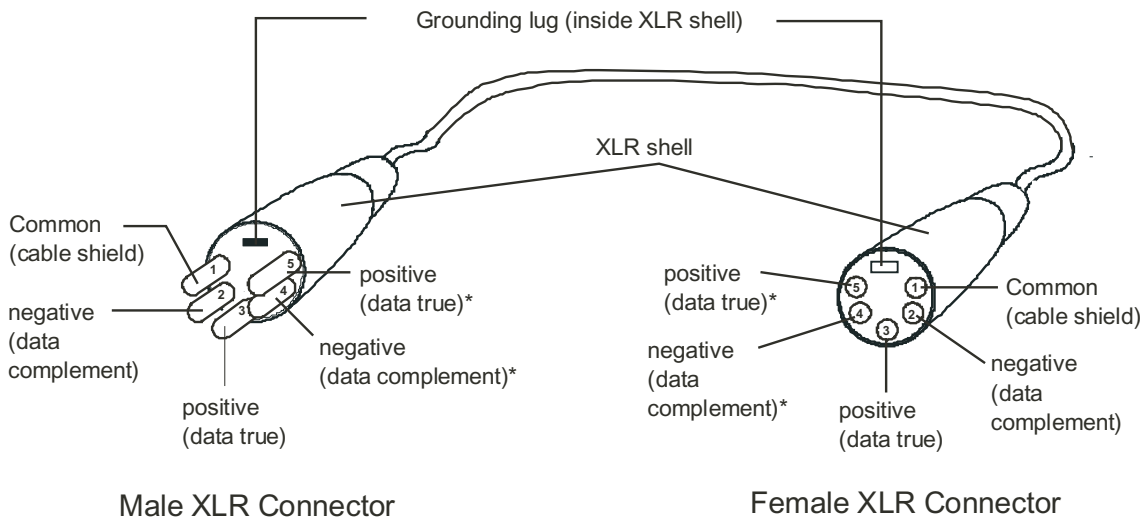
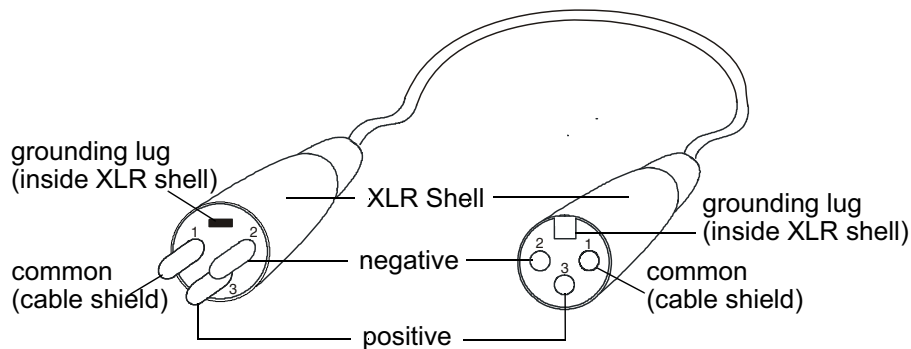

*This data line is not used by the fixture, but allows data to pass through the fixture.

Test each cable with a voltage/ohm meter (VOM) to verify correct polarity and to make sure that the negative and positive pins are not grounded or shorted to the shield or to each other.

**CAUTION!**

Do not connect anything to the ground lug on the XLR connectors. Do not connect or allow contact between the common (cable shield) and the fixture's chassis ground. Grounding the common could cause a ground loop and/or erratic behavior.

Connecting to the Link

To link one or more fixtures to a DMX controller:

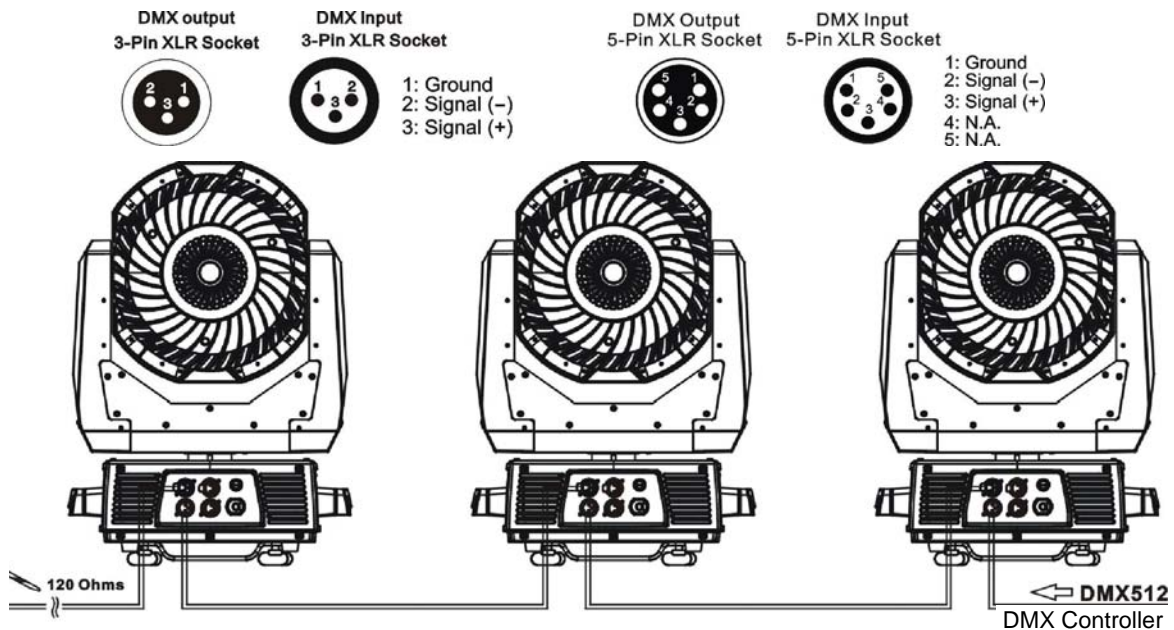

1. Connect the male XLR connector of a DMX Data cable to the controller's DMX Data Out connector.
2. Connect the Data cable's female XLR connector to the Data In connector of the first (or next) fixture on the DMX link.
3. Continue linking the remaining fixtures connecting a cable from the Data Out connector of each fixture to the Data In connector of the next fixture on the link.

For installations where the DMX cable has to run a long distance or is in an electrically noisy environment, a DMX terminator on the last fixture of the link prevents data reflection, which can corrupt the data communication on the link.

Terminate the link by installing a 120 ohm, 1/4 watt (minimum) terminator in the fixture's Data Out (female) cable connector in the last fixture on each DMX link.

To construct a terminator:

1. Disassemble a male 3-pin or 5-pin XLR connector.
2. Solder a 120 ohm resistor, minimum of 1/4 watt, between Pin 2 and Pin 3.
3. Reassemble the XLR connector.

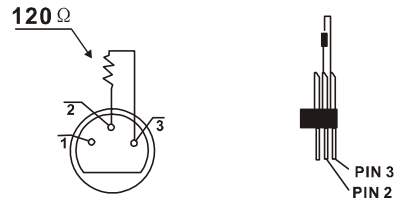

Configuring SolaWash 19 LED for DMX Control

Each SolaWash 19 LED fixture running standard protocol requires a block of 21 consecutive channels on a standard DMX512 link. Up to 24 standard SolaWash 19 LED fixtures can be assigned to a single link. For more information on Start Channels, see *Determining DMX Start Channel Assignment* on page 23. Address your fixture by setting the first channel of the channel range you want to assign this fixture on the link.



Note: *SolaWash 19 LED fixtures ship set in Standard User Mode. Other protocol options are available and require a different number of consecutive channels. The protocol selection is made in the Menu System. For information on setting a fixture to a different protocol option, see User Mode Menu on page 30.*





Addressing is done for each unit using the fixture's menu system. You can access the menu system in battery mode to Address the fixture before you mount it or apply power.

Setting a Start Channel in Battery Mode

To address a SolaWash 19 LED fixture in battery mode:

1. Turn on the menu system by pressing and holding the Battery button for two seconds. The display will show the current Function and the Start Channel currently assigned to the fixture.
2. Press the  MODE/ESC button to enter the first level of the menu system. The display will show Address and Info as the first two options in the top menu level.

The red star * indicates the option you are on as you scroll through the levels using the  and  buttons.

The number at the bottom left of the display indicates the Menu Level you are on. Address is the first option on the first level.
3. Press the  **Enter** button to choose **Address**. The currently selected Start Channel is displayed in white.
4. Using the  and  buttons, scroll through other available values (displayed in red) to the desired start channel and press  to select. The newly selected value will now appear in white the next time you enter the menu.
5. The new address will not be stored until the  **Enter** button is pressed.

Note: For a detailed description of the entire menu system, see Chapter 3: Menu System on page 17.

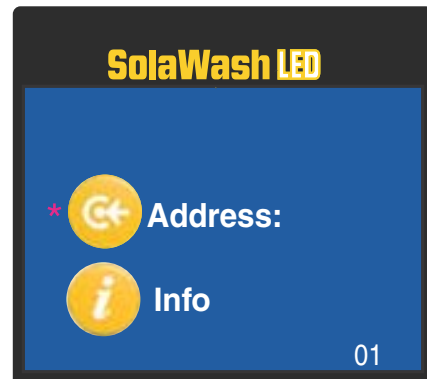

Powering On the Fixture



WARNING:

This equipment is designed for connection to a branch circuit having a maximum overload protection of 20 A.



CAUTION:

Do not power on the fixture until *verifying* that the line cord cap is suitable for the power source in your location. For more information, see *Installing a Power Cord Cap* on page 8.

Do not unplug motor harnesses while unit is powered.

To power on the SolaWash 19 LED fixture, simply connect it to a 100V-240V AC power source.

Once the SolaWash 19 LED fixture is connected to a power source, it automatically begins a homing procedure to verify that fixture components are functioning.

Shutting Down the Fixture

A DMX controller can shut down the fixture remotely with the Shutdown option in the Control Channel or you can simply disconnect from power. The SolaWash 19 LED fixture automatically shuts down in the event of DMX data loss longer than five minutes.

Chapter 3:

Menu System

This chapter shows you how to access and navigate the onboard Menu system and the options available for each menu with examples.



Menu System Overview

The front panel on SolaWash 19 LED fixtures has a full color LCD screen and navigation buttons to display and operate the onboard menu system. You can use the Menu system to perform the following functions at the fixture level:

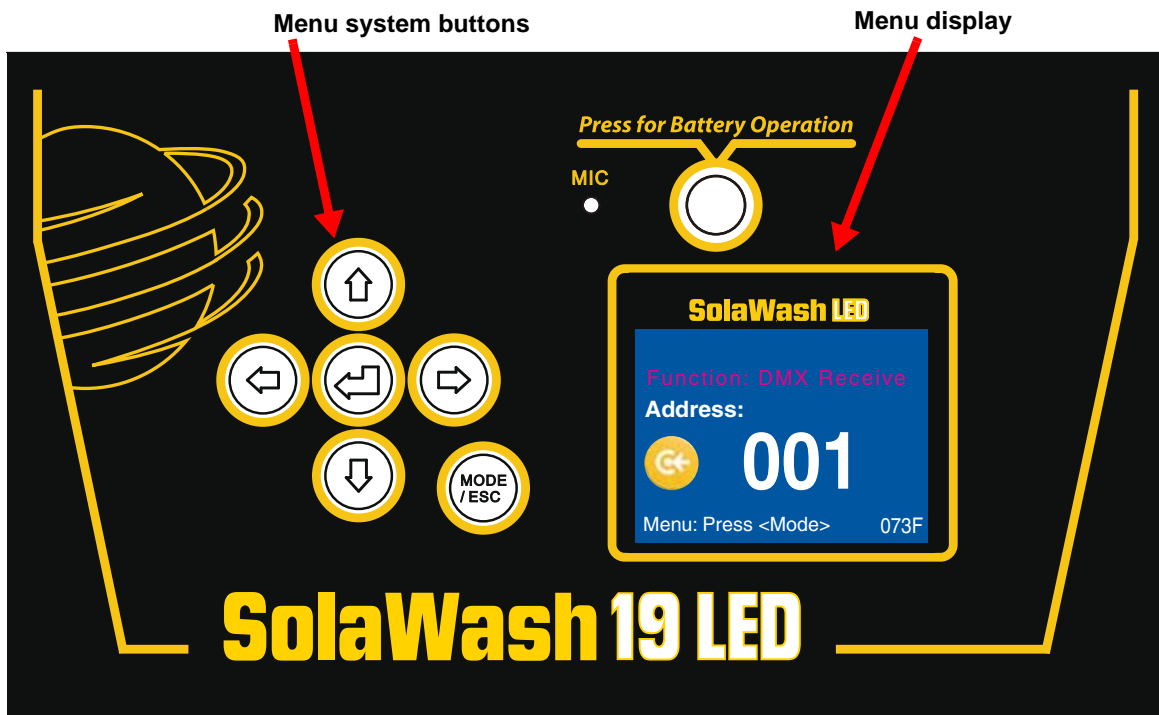
- Assign a DMX start channel
- Access and set fixture options
- View fixture status
- Create preset programs





Navigation Basics

1. Enter the Menu system by pressing the **Mode/Esc**  button for a few seconds until the menu appears.
2. The current option is displayed. Use the  and  buttons to scroll through menu options at the current level. The red star * indicates the current menu.

Note: *At the option or setting level of the menu, the currently selected option is displayed in white. Other options are displayed in red.*

3. Stop at the desired menu and press the **Enter**  button to select. If there is another level of menu choices repeat Steps 2 and 3.

Note: *The new option will not be stored unless the Enter button is pressed.*

4. Stop at the desired option and press the  button to select or press the  button to return to the previous menu level *without changing* the value of an option.

Note: *The currently selected option displays as white. Unselected options display in red.*

5. Continue pressing the  button to move back up levels until exiting the Menu system.

Note: *Some option changes do not take effect until you fully exit the menu system.*

Battery Operation

The SolaWash 19 LED fixture has an internal rechargeable battery that allows menu operation without power being applied to the fixture.





To access the display menu in this mode, press the Battery button for two seconds.

Note: *The Battery button will not respond if the fixture is receiving power.*



Exiting Battery Mode

The battery mode of the Menu will automatically switch off one minute after the last button press to conserve battery power.



To manually exit the Battery Mode:

1. Push the **Mode/Esc**  button once.
2. Use the  button to scroll to **Battery** and press the  button to select. **Exit Battery** will display in red (not currently selected).
3. Press the  button to select. The display will turn off.

SolaWash 19 LED Menu Map

Menu	Level 2	Level 3	Option/Setting	Description/Notes	
 Address	Set DMX: ###		1-484	Sets the first value of a unique 28 channel range on DMX link.	
 Info	Time Info.	Current Time	####h	Power On running time in hours	
		Ttl Life Hrs	####h	Fixture running time in hours	
		Last Run Hrs	####h	Hours at last run time reset	
		Timer PIN	XXX	Sets a Timer Password	
		Clr Last Run		Resets last run time to 0	
	Value Display	None			No DMX values are displayed
		All	XXX		Displays each parameter's current DMX value
	Head Temp	XXX°C/°F			Displays head temperature in celsius and Fahrenheit
Software Ver	VerX.XXXX			Displays software version	
 Set	Status	No DMX Mode	CloseShutter	Turns LEDs off when DMX is removed	
			Hold	Holds the current Scene	
			Auto Program	Reverts to Auto Program	
			Music Ctrl	Reverts to Music Control	
		Pan Reverse	On	Inverts Pan movement	
			Off	Default	
		Tilt Reverse	On	Inverts Tilt movement	
			Off	Default	
		Pan Degree	630/540	Manually sets Pan value in degrees	
		Encoders	On	Encoders On	
			Off	No encoder feedback	
		Pan/Tilt Spd	Speed 1-4	Selects Movement Mode	
		Mic Sens	0-99	Sets microphone sensitivity as a percentage	
		Hibernation	Off	No hibernation	
			01M-99M	Set time until hibernation in minutes	
			15M	Default Standby Mode	
	Service PIN	Service PIN	Password = ###	Service Password Default = 050	
		RDM PID	#####	Displays RDM PID	

Menu	Level 2	Level 3	Option/Setting	Description/Notes
🔧 Set	Disp. Setting	Shutoff Time	02m-60m	Time until auto shutoff in minutes
		Flip Display	On	Rotates display 180°
			Off	Default display orientation
		Key Lock	On	Locks key
	Off		Allows key operation	
	Temp. C/F	Celsius		Selects Temperature Scale
		Fahrenheit		
Reset Default	On		Resets factory defaults	
	Off		Maintains changes	
🔧 Test	Home	All		Reset all motors
		Others		Reset other motors
		Pan & Tilt		Reset Pan/Tilt motors
	Calibration	Password		Set to 050 before calibration
		0-255		Fine tunes homing position for individual motors
🔧 UserMode	Standard			Sets 21 DMX channels that include control of factory defined image patterns
	Zones			Sets 31 DMX channels that include pattern control for seven defined zones.
	Reduced			Sets 19 DMX channels for basic color wash functions only.
	Mapping			Sets 90 DMX channels that includes color control for individual LEDs

Menu	Level 2	Level 3	Option/Setting	Description/Notes
 Preset	Playback	DMX Control		Reverts to playback via console
		Set to Slave	Slave 1	Assigns slave setting
			Slave 2	
			Slave 3	
	Auto Program	Master	Assigns auto program mode	
		Alone		
	Music Control	Master	Assigns music control mode	
		Alone		
	Select Prog	Prog.Part 1	Program 1 ... Program 10	Selects program to be run in the Program part.
		Prog.Part 2	Program 1 ... Program 10	
		Prog.Part 3	Program 1 ... Program 10	
	Edit Program	Program 1 ... Program 10	Program Test	Runs the program as edited
			Step 01=SCxxx	Chooses a scene for each step in the selected program
			Step 64=SCxxx	
			End	Save and exit
	Edit Scenes	Edit Scene 001 ... Edit Scene 250	Pan ... Indigo Dim	Allows you to set a DMX value for any of the 21 parameters. (see <i>DMX Programming</i> on page 39)
			Fade Time	Lets you set a fade time value from 000–255
Scene Time			Lets you set a scene time from 00.2s–99.9s	
Input by Out			Allows you to capture DMX values for all parameters into a scene	
Scenes Input	x x - x x		Automated scene recording	
 Battery <i>Note: This menu only appears when you are in battery mode.</i>			Exit Battery	Exits the battery mode and shuts off the display.

Menu System Options

The following sections describe and give examples for selecting and/or setting available fixture configuration options.

Address Menu



Address is the top level menu selection used to set the fixture's DMX start channel. You can address the fixture before applying power in the battery mode or in normal mode after you power up the fixture.





A SolaWash 19 LED fixture requires a 21-channel range when set to run Standard protocol. The last valid Start channel for standard user mode is 492 (512–21+1).

Other protocol options are available and require a different number of consecutive channels. The protocol selection is set in the Menu System. For information on setting a fixture to a different protocol option, see *User Mode Menu* on page 30.

Setting a Start Channel

1. Turn on the menu system by pressing and holding the Battery button for two seconds. The display will show the current Function and Start Channel assigned to the fixture.
2. Press the  MODE/ESC button to enter the first level of the menu system. The display will show Address and Info as the first two options in the top menu level.

The red star * indicates the current menu as you scroll through the level using the   buttons.

The number at the bottom left of the display indicates the Menu Level you are on. Address is the first option on the first level.
3. Press the  Enter button to choose **Address**. The currently selected Start Channel is displayed in white.
4. Use the   buttons to scroll to the desired start channel and press  to select.

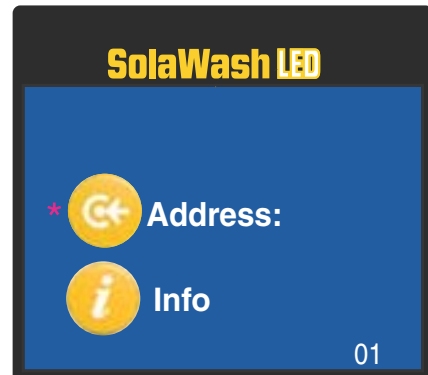
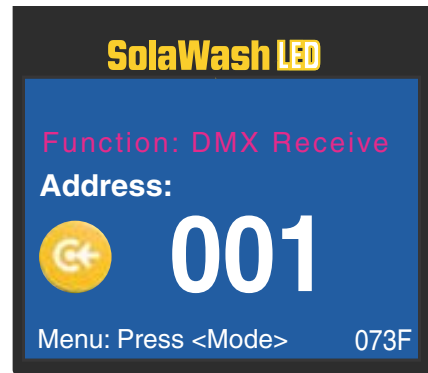

Determining DMX Start Channel Assignment

There are 512 available channels on each DMX link divided among all the devices in a particular link. A fixture must have a unique Start channel number in order to respond independently to controller commands.

To determine each fixture's DMX start channel in a link, identify the channel range of every fixture on the link. Channel range is the number of consecutive channels a fixture requires. Each SolaWash 19 LED fixture running Standard Protocol requires a block of 21 consecutive channels on a 512-Channel DMX link. The Start channel is the first number of a fixture's channel range.

When setting the Start channel on a fixture, remember:

- A fixture's physical location on the link does not have to coincide with the order of channel range assignments in the link.
- The fixture's channel range must not overlap any other device's channel range on the link. When two devices on the same DMX link have overlapping channel ranges, one or both devices will be disabled or behave erratically. The single exception would be if two or more fixtures need to respond to controller commands in exactly the same way. In that case, those fixtures must be the same type (for example two SolaWash 19 LED fixtures) with the same User Mode setting and must share the *entire* channel range.





The notes in the following table show the various considerations in determining valid Start Channels for fixtures on a 512 DMX link.

Fixture Rig Position	Fixture Type	DMX Channel Footprint	DMX Start Channel	Channel Range	Notes
First	SolaWash 19 LED in Standard User Mode	21 channels	C001	1-21	The Start channel is the first channel in a consecutive block of channels assigned to a fixture.
Third	SolaWash 19 LED in Reduced User Mode	19 channels	C029	29-47	Fixture can be assigned the second block of DMX channels without being the second fixture on the rig.
Second	Technospot	37 channels	C079	79-116	Avoid overlapping channels with other fixtures
Fourth	Studio Spot	18 channels	C121	121-138	Every channel in the link does not need to be assigned.

Information Menu

The Information menu displays current fixture information such as internal temperature, total fixture hours, software version, and DMX values for each of the fixture's parameters. Fixture hours resets are also executed in the Information Menu.

To enter the Information Menu:

1. Press the  MODE/ESC button to enter the first level of the menu system. The display will show **Address** and **Info** as the first two options in the top menu level.
2. Using the   buttons, scroll to **Info**.
3. Press the  button to select.



Time Info

The Time Info menu displays or resets the following time functions.

Current Time: Power On running time in hours

Ttl Life Hrs: Fixture running time in hours









Last Run Hrs: Hours at last run time reset

Timer PIN: Use   buttons to set a Timer Password (Default PIN = 038)

Clr Last Run: OFF is the default value. Select ON to reset run time to 0

Use this Menu option to trace total fixture hours and set run times for individual shows.







For example, to reset run time to 0:

1. Navigate to and select **Info** menu as shown above. **Time Info** is the first option you will view. Press the  button to select.
2. Using the   buttons, scroll to **Clr Last Run** and press the  button to select.
3. Use the   buttons to scroll to ON and press the  button to select.
4. Press the  button to reset the run time to 0 or  to return to previous menu level.

Values Display

This menu option lets you view the current DMX value for each of the fixture's parameters.

To view DMX values by Parameter:



1. Navigate to and select the **Info** menu as shown on *page 24*.
2. Using the   buttons, scroll to **Values Display** and press the  button to select.
3. Using the   buttons, scroll to any of the DMX parameters in the SolaWash 19 LED protocol and press the  button to view its current DMX decimal value.

Note: *The parameter number and name will vary depending on the DMX protocol options being used. See Chapter 5: SolaWash 19 LED DMX Protocol Options on page 40 and User Mode Menu on page 30.*

Head Temperature

The SolaWash 19 LED fixture contains temperature sensors that monitor the air temperature inside the housing near the display board.

To view temperature:



1. Navigate to and select the **Info** menu as shown on *page 24*.
2. Using the   buttons, scroll to **Head Temp** and press the  button to select.

The temperature will be displayed in degrees Celsius or Fahrenheit depending on which scale is currently selected in the **Set** menu, see *Temp C/F* on page 28.

Software Version

This Info menu option displays the current fixture software loaded on the unit. Software versions can vary even between units purchased at the same time.

To view fixture:

1. Navigate to and select the **Info** menu as shown on *page 24*.
2. Using the   buttons, scroll to **Software Ver** and press the  button to select.
Software version will be displayed in the form VX.XXXX

Set Menu

The Set Parameters menu lets you configure your fixture's motion, display, and data source settings.

To enter the Set menu:

1. Press the  MODE/ESC button to enter the first level of the menu system. The display will show **Address** and **Info** as the first two options in the top menu level.

*The red star * indicates the current option.*

2. Using the   buttons, scroll to **Set**.
3. Press the  button to select.

Status Options

This menu lets you configure the fixture functions listed below.

No DMX Mode

This option determines the fixture state after the DMX signal is removed. The Default setting is **Hold**. You can choose from the following options:

CloseShutter: Shuts LEDs off when DMX is removed

Hold: Holds the current values for all parameters

Auto Program: Reverts to Auto Program Playback

Music Ctrl: Reverts to Music Control Playback

Pan Reverse

This menu option inverts the direction of the pan motor to coordinate movements between fixtures mounted opposite each other horizontally. The default setting is **Off**. **On** inverts the fixture's Pan motion.

Tilt Reverse

This menu option inverts the direction of the tilt motor to coordinate movements between fixtures on a link facing each other vertically. The default setting is **Off**. **On** inverts the fixture's Tilt motion.

Pan Degree

The standard pan range of a SolaWash 19 LED fixture is 0–540°. This option lets you expand the pan range to an upper limit of 630°. To expand the pan range, scroll from the default option of **540** to **630** and press the  button to select.

Encoders

Encoders maintain the Pan and Tilt position of the fixture, but may need to be disabled to perform certain test and maintenance procedures. The default setting is **On**. To disable encoders, select the **Off** option.

Pan/Tilt Speed

This options adjusts the maximum movement speed of the pan and tilt parameters. The **Speed 1** option is the default normal movement speed. **Speed 2**, **Speed 3**, and **Speed 4** options are progressively slower maximum movement speeds.











Mic Sensitivity

You can adjust the input level for the internal microphone by setting this option from **0% –99%**. The Default value is **70%**.

Hibernation

This menu option determines when the fixture shuts down after DMX data loss. You can choose any time between 1 minute and 99 minutes after data loss to shutdown. The default setting is **15M**. Selecting **Off** will shutdown the fixture immediately upon loss of DMX signal.









For example, to change the Hibernation time from the default setting:

1. Navigate to and select the **Set** menu as shown above.
2. Using the   buttons, scroll to **Status** and press the  button to select.
3. Using the   buttons, scroll to **Hibernation** and press the  button to select. The default setting of 15M will be displayed.
4. Using the   buttons, scroll to a number of minutes between 1 and 99 and press  to select or  to return to the last menu level.

Service Setting

Two options for service setting allow you to set a **Service Password** or a **RDM PID** code.

To change the Service Password:

1. Navigate to and select the **Set** menu as shown on *page 26*.
2. Using the   buttons, scroll to **Status** and press the  button to select.
3. Using the   buttons, scroll to **Service PIN** and press the  button to select. The current password will be displayed. The default is **Password = 050**.
4. Using the   buttons, scroll to a 3-digit number and press the  button to select as the new service password.

Note: *A service password must be set before you can enter a six digit RDM PID number.*

Display Setting

The following Display options let you control how the display functions.

Shutoff Time

This option lets you determine when the display automatically shuts off after the last button push. You can choose a delay from **02 – 60** minutes. The default delay setting is **05** minutes.









Flip Display

Use this option to rotate the display 180° when that orientation is easier to view. **Off** is the default setting. Select **On** to flip the display. Note that this option only takes effect once you exit the menu system by pressing the  MODE/ESC button.

Key Lock

This display setting lets you activate a key lock. **Off** is the default. Select **On** to activate the key lock and then press and hold the  MODE/ESC button for 2 seconds when you want to unlock the menu. When this function is activated, the keys will lock automatically after exiting the edit mode for 15 seconds.

For example, to change the **Shutoff Time**:

1. Navigate to and select the **Set** menu as shown on *page 26*.
2. Using the   buttons, scroll to **Display Setting** and press the  button to select.
3. Using the   buttons, scroll to **Shutoff Time** and press the  button to select.
4. Using the   buttons, scroll to a time between 2 and 60 minutes and press the  button to select.

Temp C/F







This option sets the temperature scale to **Celsius** or **Fahrenheit**. Celsius is the default setting.

Reset Default

This **Set** option lets you return all factory options. The default setting is **Off**. SolaWash 19 LED fixtures ship with the following factory default settings:

Pan Reverse = Off	Encoders = On	Flip display = Off
Tilt Reverse = Off	No DMX Mode = Hold	Keylock = Off
Hibernation = 15 minutes	Temp C/F = Celsius	Microphone Sensitivity = 70%
Movement Speed = Speed 1	Shutoff Time = 5 minutes	User Mode = Standard
Pan Degree = 540	Service Password = 050	Time Info = Off

To reset the unit to factory defaults:

1. Navigate to and select the **Set** menu as shown on *page 26*.
2. Using the   buttons, scroll to **Reset Defaults** and press the  button to select.
3. Using the   buttons, scroll to **On** and press the  button to select.



Test Options Menu

This menu lets you manually Home the fixture and change DMX values for parameters.

To Enter the **Test Options** Menu:

1. Press the  MODE/ESC button to enter the first level of the menu system. The display will show **Address** and **Info** as the first two options in the top menu level.

*The red star * indicates the current option.*

2. Using the   buttons, scroll to **Test**.
3. Press the  button to select.

Homing the Fixture





The SolaWash 19 LED fixture automatically homes whenever it is connected to power. The following options are available to let you manually home all the fixture motors or motors for specific functions:

All: Reset all motors

Others: Reset other motors

Pan & Tilt: Reset Pan/Tilt motors









For example, to manually home the pan and tilt motors:

1. Navigate to and select the **Test** menu as shown above.
2. Using the  buttons, scroll to **Home** and press the  button to select.
3. Using the   buttons, scroll to **Pan & Tilt** and press the  button to select. The fixture automatically begins homing the Pan and Tilt motors.

Calibration

This **Test** menu option lets you fine tune the home position for Pan and Tilt motors.

For example, to calibrate **Pan** motor after homing:

1. Navigate to and select the **Test** menu as shown above.
2. Using the   buttons, scroll to **Calibration** and press the  button to select.
3. Using the   buttons, scroll to **Pan** and press the  button to select.
4. Using the   buttons, adjust the Gobo Wheel 1 offset value and press the  button to store the calibration adjustment.

User Mode Menu

Use this menu to select the Protocol option you want to use for DMX control. The SolaWash 19 LED has four user mode options each with different control features and channel requirements:

DMX Control Features	Protocol Option Control Features			
	Standard (21 Channels)	Zones (31 Channels)	Reduced (19 Channels)	Mapping (90 Channels)
Pan	X	X	X	X
Tilt	X	X	X	X
RGBW Color	X	X	X	X
CMYW Color	X	X	X	
Cycle Color	X	X	X	
Random Color	X	X	X	
Zone Pattern Selection		X		
Color Mixing by Zone		X		
Individual LED Color Mixing				X
Color Correction	X	X	X	X
Zoom	X	X	X	X
Strobe	X	X	X	X
Dim	X	X	X	X
Image Select and Play Speed	X			
MSpeed	X	X	X	X
Control	X	X	X	X
Indigo Highlighter Function/Dim	X	X	X	X

The factory default is **Standard User Mode**. See *Chapter 5: DMX Programming* on page 39 for a detailed description of parameter options offered in each User Mode.



To Enter the **User Mode** Menu:

1. Press the  MODE/ESC button to enter the first level of the menu system. The display will show **Address** and **Info** as the first two options in the top menu level.

*The red star * indicates the current option.*

2. Using the   buttons, scroll to **User Mode** and press the  button to select.

To select a User Mode:





3. Using the   buttons, scroll to the protocol option you want (**Standard**, **Reduced**, **Zones**, **Mapping**) and press the  button to select.

Preset Menu

The preset menu allows you to program scenes directly to the fixture. The options for designing and playing back presets are described in *Chapter 4: Preset Programming* on page 33.

Battery Menu

This menu is only available when you are currently operating in Battery Mode. Use the following steps to return to normal power mode:

1. Push the **Mode/Esc**  button.
2. Use the  button to scroll to **Battery** and press the  button to select. **Exit Battery** will display in red (not currently selected).
3. Press the  button to select. The display will turn off.

Chapter 4:

Preset Programming

SolaWash 19 LED fixtures can be programmed through the onboard menu system using Preset Programming. This section describes how to program your fixtures for stand-alone operation using the on-board memory in each fixture to create and store scenes.

Preset Programming Overview

Presets are built from combining scenes into programs and then assigning the programs to Program Partitions for playback by a fixture designated as the Master and, if desired, groups of slave fixtures assigned to a Program Partition. SolaWash 19 LED fixtures ship with factory programmed scenes and programs ready for you to use or edit.

Creating presets consists of performing the following steps:

- **Designating a fixture as the Master**
- **Selecting/Editing Scenes**
- **Sequencing Scenes into Programs**
- **Sequencing Programs into Program Partitions**
- **Configuring slave fixtures on the link to playback a Program Partition from the master**

Navigating to the Preset Menu

To enter the Preset Menu:

1. Press the  MODE/ESC button to enter the first level of the menu system. The display will show **Address** and **Info** as the first two options in the top menu level.

The red star * indicates the current menu.

2. Using the   buttons, scroll to **Preset**.
3. Press the  button to select.

Master and Slave

The following example shows the relationship between scenes, programs and partitions programmed on the Master and how slave groups are assigned.

- Groups of scenes are edited into Programs 1– 6 on the fixture designated as Master
- Program 2 is assigned to Part 1
- Program 4 is assigned to Part 2
- Program 6 is assigned to Part 3
- Fixtures assigned as Slave 1 playback Part 1
- Fixtures assigned as Slave 2 playback Part 2
- Fixtures assigned as Slave 3 playback Part 3

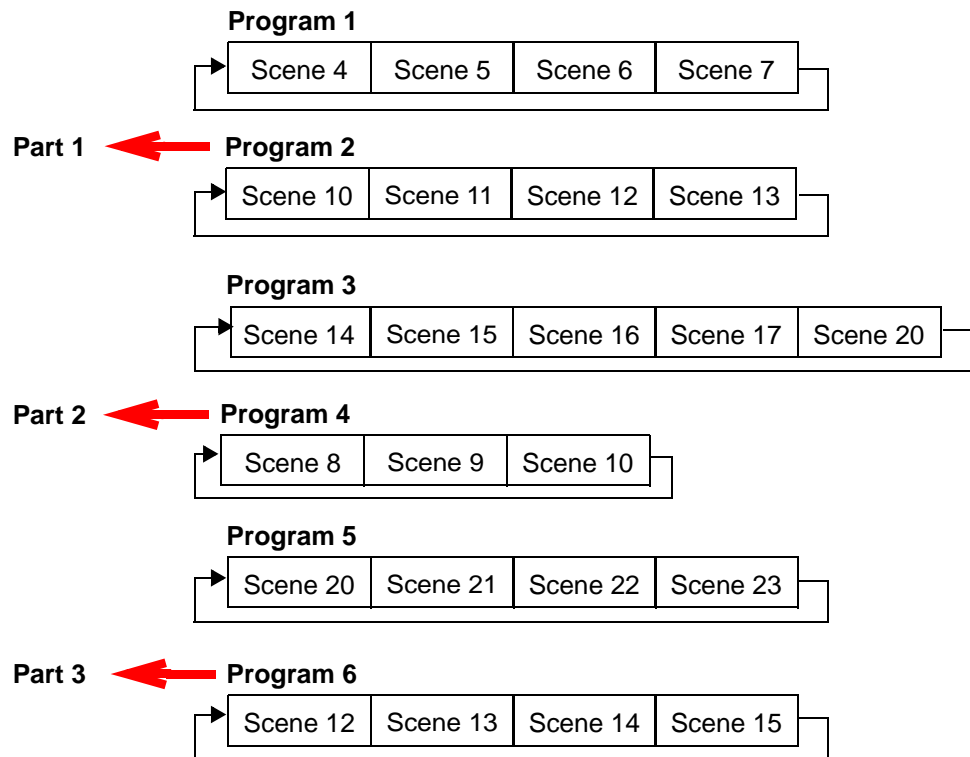

Preset Menu

Playback Settings









Preset programming requires one fixture to act as the Master. All other SolaWash 19 LED fixtures on the link running the same user mode can then be set as slaves to playback the Master presets. Slave fixtures receive all their preset parameter and timing information from the master fixture.

Playback settings designate a fixture as a master or a slave and also allow you to revert from Auto Programming to DMX control from a console or set a fixture in Master or standalone mode for audio control.

Automatic Program Run

This Playback option lets you designate a fixture to playback in Standalone mode or as a Master. **Alone** is the default setting.









To designate a fixture as a Master:

1. Navigate to and select the **Preset** menu as shown on *page 35*.
2. Use the   buttons to scroll to **Playback** menu and press  to select.
3. Use the   buttons to scroll to **Auto Program** menu and press  to select.
4. Use the   buttons to scroll to **Master** and press  to select. Your choice will be shown in the display.

Set to Slave

After a preset program is defined on a Master fixture, other SolaWash 19 LED fixtures on the same DMX link can be designated slaves to playback Program Part 1, 2 or 3 as defined on the Master fixture, see *Select Program* on page 38.

To designate a fixture as a Slave:

1. Navigate to and select the **Preset** menu as shown on *page 35*.
2. Use the   buttons to scroll to **Playback** menu and press  to select.
3. Use the   buttons to scroll to **Set To Slave** menu and press  to select.
4. Use the   buttons to scroll to **Slave1**, **Slave2**, or **Slave3** option and press  to select. Your choice will be shown in the display.

DMX Control

Selecting this option reverts the function from **Auto Program** (Preset Programming) to **DMX Receive** (console control). Selecting this option will take you back to the menu startup screen where **DMX Receive** will be displayed as the currently selected function.

Music Control

This Playback option lets you designate a fixture to playback scenes based on audio triggers detected by the internal microphone in stand alone or as a Master. **Alone** is the default setting.

Edit Scenes













A parameter is a fixture attribute that can be controlled to modify the light beam in terms of color, beam quality and pattern, intensity, or focus (position). DMX programming assigns a DMX value to each of the fixture's parameters. A *scene* is one combination of parameter settings.

SolaWash 19 LED fixtures provide 250 pre-programmed scenes you can use or edit to build a preset program. The first 64 scenes have factory created settings which can be edited as desired.

Edit Scene Parameters

The **Edit Scenes** option lets you select a DMX value for any of the 28 parameters in the SolaWash 19 LED DMX protocol.

To edit the DMX parameters in a scene:

1. Navigate to and select the **Preset** menu as shown on *page 35*.
2. Use the   buttons to scroll to the **Edit Scenes** option and press  to select.
3. Use the   buttons to scroll to the Scene number you wish to build on from 1-250 and press  to select.
4. Use the   buttons to scroll to the parameter you wish to edit (**Pan, Tilt, MSpeed, Color Wheel**, etc.) and press  to select.
5. Use the   buttons to scroll to a new DMX value for the parameter you have selected and press  to select.

This takes you back to parameter options. Continue through all parameters until your desired look is complete. See *Chapter 5: DMX Programming* on page 39 to find parameter values for the option you want to assign.

6. When you are finished selecting all parameter values for a particular Scene, press the  button to return to the **Preset** level menu.

Edit Scene Time











This Scene Edit option lets you set the scene time in seconds from **00.2s–99.9s**. The default value is **00.3s**. This values determines how long the scene will play before the next scene is triggered.

Set Fade Time

This Scene Edit option lets you set a fade time value from **000–255**. This values determines the crossfade time applied to parameters once the scene is triggered.

Set Input by Out













This Scene Edit option allows you to capture the parameter values for a scene from DMX input into the fixture. Once you create a look from a DMX console do the following:

1. Navigate to and select the **Preset** menu as shown on *page 35*.
2. Use the   buttons to scroll to the **Edit Scenes** option and press  to select.
3. Use the   buttons to scroll to the Scene number you wish to build on from 1-250 and press  to select.
4. Use the   button to scroll to the **Input by Out** and press  to select.
5. The scene will record the current parameter values being input via DMX.
6. When you are finished capturing DMX into a scene, press  to return to the main menu.

Edit Program

This preset menu option lets you select from 10 factory set programs to edit. You can set up to 64 **Scenes** in a sequence of **Steps** for each program. You can also test the program at any time by selecting **Program Test** to playback the program as it is currently defined.

To edit a program:





















1. Navigate to and select the **Preset** menu as shown on *page 35*.
2. Use the   buttons to scroll to **Edit Prog.** menu and press  to select.
3. Use the   buttons to scroll to a program from **Program 1–Program 10** and press  to select.
4. Use the   buttons to scroll to the Step in the program you want to edit from **Step 1** to **Step 64** and press  to select. The display will show which scene is currently assigned to that step.
5. Use the   buttons to scroll to the scene you want to assign to the step and press  to select.
6. When you have assigned all the steps you want, select End and press  to save the program.

Select Program

This preset option lets you assign a Preset Program to one of three Program Partitions. A fixture assigned as a Slave can playback any Program Partition defined by the Master fixture.







Note: The Master fixture can only playback Program Partition 1

To assign a program to each Program Partition:

1. Navigate to and select the **Preset** menu as shown on *page 35*.
2. Use the   buttons to scroll to **Select Prog** menu and press  to select. Each Program Part, has 10 preset programs.
3. Use the   buttons to scroll to **Prog. Part 1** and press  to select.
4. Use the   buttons to scroll to a program from **Program 1–Program 10** and press  to select the program you want to include in the Program Part.
5. Use the   buttons to scroll to **Prog. Part 2** and press  to select.
6. Use the   buttons to scroll to a program from **Program 1–Program 10** and press  to select the program you want to include in the Program Part.
7. Use the   buttons to scroll to **Prog. Part 3** and press  to select.
8. Use the   buttons to scroll to a program from **Program 1–Program 10** and press  to select the program you want to include in the Program Part.
9. Press the  button to return to the main menu.

Scenes Input

This function allows you to capture multiple scenes from DMX values input to the fixture. You first define the number of scenes to capture and then each time a DMX value changes, a different scene will be captured.

1. Navigate to and select the **Preset** menu as shown on *page 49*.
2. Use the   buttons to scroll to the **Scenes Input** option and press  to select.
3. Use the   buttons to set the starting scene number.
4. Use the   buttons to set the ending scene number. With each change of any DMX value, the capturing scene will advance to the next one in the range.
5. When all scenes have been recorded, the scenes input menu will automatically exit.

Note: During Scenes Input recording, the SolaWash 19 LED does not playback the DMX input, it only captures it. You must edit or playback the scenes after recording to see the results. It is best to prepare the scenes on a DMX controller with a zero crossfade for all parameters between each step. Remember any change of a DMX value will advance to the next scene to capture.

Chapter 5:

DMX Programming

Multiple DMX protocol options let you program SolaWash 19 LED fixtures as a general wash light or with added pixel and pattern control. This chapter describes DMX programming options and SolaWash 19 LED DMX parameters.

DMX Programming Overview

A parameter is a fixture attribute that can be controlled to modify the light beam in terms of color, beam quality and pattern, intensity, or focus (position). DMX programming assigns a DMX value to each of the fixture's parameters. A *scene* is one combination of parameter settings. Scenes are the building blocks for show creation.

Full Speed versus MSpeed Control

Some parameters can be set to operate at full speed or MSpeed (motor speed). Full speed operations are completed in the shortest length of time after the motor starts moving. With MSpeed control, change occurs smoothly over the entire MSpeed time value selected. For example, if you select an MSpeed time of 30 seconds, the motor will gradually change position until it reaches its new destination at the end of 30 seconds. SolaWash 19 LED fixtures allow optional MSpeed control for pan and tilt movement parameters.

16-bit Functionality

Several parameters use two channels to provide 16-bit control for very fine adjustment.

DMX Programming Options

Using a DMX controller, you can program an unlimited number of looks and retain direct control over the SolaWash 19 LED fixture at all times. SolaWash 19 LED fixtures also allow Preset programming through the fixture menu system, see *Chapter 5: Preset Programming* on page 47.

Programming with a DMX Console

Hog[®] 4, Road Hog[®] 4, HedgeHog 4, and Full Boar 4 lighting consoles; and Hog[®] 4PC software are available from High End Systems to control SolaWash 19 LED fixtures. For information on whether your DMX controller supports SolaWash 19 LED fixtures, contact the controller's vendor. For information on operating your fixture with a controller (or control device such as DMX control software), consult the documentation provided with the controller.

SolaWash 19 LED DMX Protocol Options

Four protocol options are available for SolaWash 19 LED fixtures. All provide full color mixing and color correction as well as Zoom, Strobe, Dim, MSpeed and Indigo Highlighter functions.

- Standard Protocol uses 21 DMX channels. In addition to basic fixture functions, it includes control of factory defined static images and image animations.
- Zones Protocol uses 31 DMX channels to include color control for up to 4 zones in seven defined patterns.
- Reduced Protocol defines 19 DMX channels for basic color wash light functions.
- Mapping Protocol uses 90 DMX channels to let you color mix each of the fixture array's 19 LEDs independently. Indigo highlighter LED are still controlled separately.

You select the protocol for an individual fixture in the display menu system (see *User Mode Menu* on page 30).

Standard Protocol

Channel	Function
1	Pan
2	
3	Tilt
4	
5	Color Function
6	Red
7	Green
8	Blue
9	White
10	Color Correction

Channel	Function
11	Zoom
12	
13	Strobe
14	Dim
15	
16	Image
17	Image Play Speed
18	MSpeed
19	Control
20	Indigo Highlighter Function
21	Indigo Highlighter Dim

Zones Protocol

Channel	Function
1	Pan
2	
3	Tilt
4	
5	Color Correction
6	Zoom
7	
8	Strobe
9	Dim
10	
11	MSpeed
12	Control
13	Color Function
14	Red (Zone 1)
15	Green (Zone 1)

Channel	Function
16	Blue (Zone 1)
17	White (Zone 1)
18	Red (Zone 2)
19	Green (Zone 2)
20	Blue (Zone 2)
21	White (Zone 2)
22	Red (Zone 3)
23	Green (Zone 3)
24	Blue (Zone 3)
25	White (Zone 3)
26	Red (Zone 4)
27	Green (Zone 4)
28	Blue (Zone 4)
30	White (Zone 4)
30	Indigo Highlighter Function
31	Indigo Highlighter Dim

Reduced Protocol

Channel	Function
1	Pan
2	
3	Tilt
4	
5	Color Function
6	Red
7	Green
8	Blue
9	White
10	Color Correction

Channel	Function
11	Zoom
12	
13	Strobe
14	Dim
15	
16	MSpeed
17	Control
18	Indigo Highlighter Function
19	Indigo Highlighter Dim

Mapping Protocol

Chan.	Function	Chan.	Function	Chan.	Function
1	Pan	31	LED 5 Blue	61	LED 13 Red
2		32	LED 5 White	62	LED 13 Green
3	Tilt	33	LED 6 Red	69	LED 13 Blue
4		34	LED 6 Green	64	LED 13 White
5	Color Correction	35	LED 6 Blue	65	LED 14 Red
6	Zoom	36	LED 6 White	66	LED 14 Green
7		37	LED 7 Red	67	LED 14 Blue
8	Strobe	38	LED 7 Green	68	LED 14 White
9	Dim	39	LED 7 Blue	69	LED 15 Red
10		40	LED 7 White	70	LED 15 Green
11	MSpeed	41	LED 8 Red	71	LED 15 Blue
12	Control	42	LED 8 Green	72	LED 15 White
13	LED 1 Red	43	LED 8 Blue	73	LED 16 Red
14	LED 1 Green	44	LED 8 White	74	LED 16 Green
15	LED 1 Blue	45	LED 9 Red	75	LED 16 Blue
16	LED 1 White	46	LED 9 Green	76	LED 16 White
17	LED 2 Red	47	LED 9 Blue	77	LED 17 Red
18	LED 2 Green	48	LED 9 White	78	LED 17 Green
19	LED 2 Blue	49	LED 10 Red	79	LED 17 Blue
20	LED 2 White	50	LED 10 Green	80	LED 17 White
21	LED 3 Red	51	LED 10 Blue	81	LED 18 Red
22	LED 3 Green	52	LED 10 White	82	LED 18 Green
23	LED 3 Blue	53	LED 11 Red	83	LED 18 Blue
24	LED 3 White	54	LED 11 Green	84	LED 18 White
25	LED 4 Red	55	LED 11 Blue	85	LED 19 Red
26	LED 4 Green	56	LED 11 White	86	LED 19 Green
27	LED 4 Blue	57	LED 12 Red	87	LED 19 Blue
28	LED 4 White	58	LED 12 Green	88	LED 19 White
29	LED 5 Red	59	LED 12 Blue	89	Indigo Highlighter Function
30	LED 5 Green	60	LED 12 White	90	Indigo Highlighter Dim

Parameter Descriptions

In the following sections, parameters are listed alphabetically and their functions are described in detail.

Note: *All DMX values indicated in the detailed parameter descriptions are in decimal units.*

Color Correction Parameter

The **Color Correction** parameter adjusts the color temperature appearance of the LED output from low at a DMX value of 1 to normal at a DMX value of 128. This parameter is part of each protocol option. The default for **Color Correction** is Off when the DMX value = 0.

Color Mixing Parameters

The **Red**, **Green**, **Blue** and **White** parameter channels control the saturation (brightness level) of each color for color mixing. Values for each color parameter range from Off when the DMX value = 0 to fully On when the DMX value = 255.

In Standard and Reduced Protocol, four color channels mix color for all array LEDs. Zones protocol assigns four color parameter channels for each zone. Mapping Protocol assigne four channels to each LED in the array.

The **Color Function** parameter offers multiple options for controlling the LED color mixing and output.

Note: *The Color Function parameter is not included in the Mapping Protocol options.*

Standard and Reduced Protocol Color Function Options

Color Function	DMX Value	Description
RGB	0-23	Mixes Red, Green and Blue and White
CMY	24-47	Mixes inverse of RGB plus White. Red = Cyan, Green = Magenta, Blue = Yellow
Cycle	48-79	Cycles through all the colors. Red channel controls cycle speed from slow to fast
Random	80-127	Randomly selects color. Red channel controls intervals from slow to fast.

Zones Protocol Color Function

In addition to the standard **Color Function** options, Zone protocol provides additional color channels to control color mixing in each zone of seven patterns. Values for each color parameter range from Off when the DMX value = 0 to fully on when the DMX value = 255.

Color Function	DMX Value	Description
All LEDs Control - Mix colors using DMX channels 14-17		
RGB	0-23	Mixes Red, Green and Blue plus White
CMY	24-47	Mixes inverse of RGB plus White. Red = Cyan, Green = Magenta, Blue = Yellow
Cycle	48-79	Cycles through all the colors. Red channel controls cycle speed from slow to fast
Random	80-127	Randomly selects color. Red channel controls intervals from slow to fast.
All Zones	200-255	Treats all LEDs as a single zone for color mixing
Zone LED Control - Mix colors using DMX channels 14-29		
Pattern 1	128-137	For each pattern, color mix Zone 1 LEDs with Color channels 14-17, Zone 2 LEDs with Color channels 18-21, Zone 3 LEDs with Color channels 22-25 and Zone 4 LEDs with Color channels 26-29. <i>Note: Color channels 26-29 are inactive for Zone Pattern 1 since only three zones are used to create the pattern.</i>
Pattern 2	138-147	
Pattern 3	148-157	
Pattern 4	158-167	
Pattern 5	168-177	
Pattern 6	178-187	
Pattern 7	188-197	

Zone Pattern Options

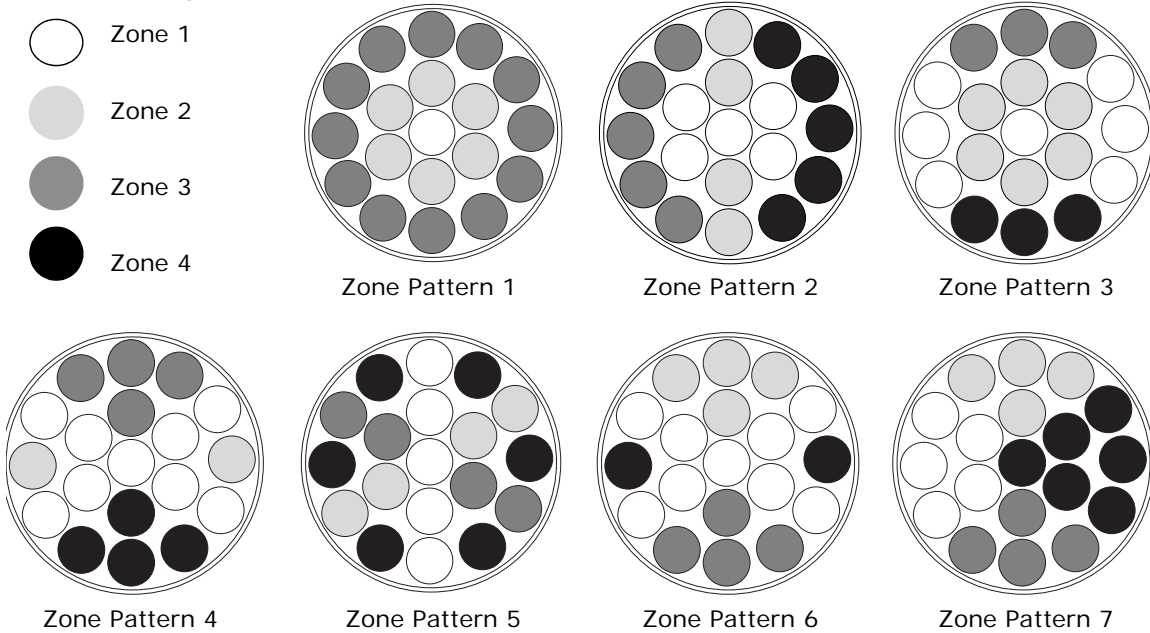

Control Parameter

The **Control** parameter allows remote control of Display, Homing, Lamp and Shutdown.

Control Setting	DMX Value	Description
Safe	0-9	Disables all Control settings for normal operation
Display Off	20-28	Turns display off
Display On	29-48	Turns display on
Home All	49-68	Remotely homes all the fixture components
Shutdown	69-130	Remotely shuts down the fixture. When a fixture is shut down, the LEDs are off and power to the motors is disabled. If a fixture is in shutdown mode, the fixture must be homed to bring it back into operation.
Pan and Tilt Home	131-140	Homes the driver motors for specific fixture components.
Other Motor Home	141-150	
Audio Sync	151-160	Synchronizes audio playback
Internal Program 1	161-171	Selects one of the seven factory-programmed 8-step scenes to play as a macro
Internal Program 1	172-182	
Internal Program 1	183-193	
Internal Program 1	194-204	
Internal Program 1	205-215	
Internal Program 1	216-226	
Internal Program 1	227-237	

Dim Parameter

SolaWash 19 LED fixtures provide 16-bit brightness control utilizing the Dim Coarse and Dim Fine parameter without changing the color temperature or the beam shape. The dim values range from Off when the DMX value = 0 to fully on when the DMX value = 255.

Image Parameters

Note: *Image Parameters are found only in the Standard User mode protocol*

The **Image** parameter lets you select from an array of static patterns and groups of patterns that can be played together to create unique animations. A selected image or animation pattern can be color mixed using the Color parameters.

Image Options	DMX Value	Description
Solid	0	All LEDs are on
Static Images	101-102	Isolates a group of LEDs in patterns that can be colorized
Animations	103-254	Static images play to create an animation. Color is static and cannot be changed.
Solid	248-255	All LEDs are on

The **Image Play Speed** parameter provides variable control of the animation speed from slow when the DMX value = 0 to fast when the DMX value = 255.

Indigo Highlighter Parameters

Indigo Highlighter system consists of 16 highlighters each of which contains four 1-watt indigo LEDs. Two parameters define the Indigo Highlighter operation.

The **Indigo Highlighter Function** parameter lets you choose between continuous or strobed output and whether to have the Indigo Highlighter system function independently from fixture dimming or track it.

Indigo Highlighter Function	DMX Value	Description
Continuous	0-15	Tracks the fixture dimming with continuous output
Periodic Strobe	16-41	Tracks the fixture dimming with periodic strobing from slowest to fastest
Continuous	128-143	Continuous output independent from fixture dimming
Periodic Strobe	144-169	Strobing output independent from fixture dimming from slowest to fastest

The **Indigo Highlighter Dim** parameter adjusts the Indigo Highlighter LEDs from Off when the DMX value = 0 to fully On when the DMX value = 255.

MSpeed (Motor Speed)

MSpeed is the time required for a motor to complete movement when changing from one position to another. In SolaWash 19 LED fixtures, MSpeed provides a means for Pan and Tilt motors to reach their target position at the same time, even though each motor may have different distances to travel. MSpeed movement is extremely smooth because the fixture controls movements independent of DMX refresh rates.

MSpeed times vary from 0.15 seconds to 252.7 seconds. However, when MSpeed is applied to a parameter, the delay value (length of time allowed for the entire scene) needs to be longer than the MSpeed value to allow the motors to complete their movement before the end of the scene. An MSpeed value that is longer than the delay value could produce an undesirable result; for example, no light output during the scene. For a listing of exact MSpeed times, see *Chapter A: MSpeed Conversion Table* on page 57.

Pan and Tilt Parameters

The SolaWash 19 LED fixture has a 540° pan range and a 265° tilt range. Two DMX channels provide 16-bit adjustment to a fraction of a degree for pan and tilt position. SolaWash fixtures also have an option for a 630° pan range that you can select in the Info section of the Menu system, (see *Pan Degree* on page 26).

An MSpeed function is available for Pan and Tilt parameters when the MSpeed parameter. For information on implementing MSpeed, see *MSpeed (Motor Speed)* above.

Note: *Optical encoders for pan and tilt instantly correct the fixture's position if the fixture is jarred from its programmed position. If a physical obstruction prevents the fixture from correcting its position, the fixture "times out" to prevent wear on the motors. If the fixture has timed out, remove the obstruction and home the fixture to return it to normal operation.*

Strobe Parameter

LEDs can be turned on and off to create different strobe effects set in the **Strobe** parameter. Off is the default when the DMX value = 0.

Strobe Options	DMX Value	Description
Synchronous strobe	1-100	Strobes the output at equal intervals from slow to fast
Random Random Strobe	101-177	Strobes at random intervals
Synchronous Random Strobe	178-254	Synchronizes random strobing for all SolaSpot 19 LED fixtures using the same DMX controller
Off	0 and 255	Discontinues strobing

Zoom Parameter

The SolaWash 19 LED fixture has a continuous zoom ranging from 12° to 65°. The **Zoom Coarse** and **Zoom Fine** parameters provide 16-bit continuous control for smooth and precision zoom function from narrow when the DMX value = 0 to wide when the DMX value = 255.

Chapter 6:

General Maintenance and Troubleshooting

This chapter outlines safety and maintenance procedures as well as troubleshooting error messages.

Safety Considerations



CAUTION: The information in this chapter is intended to assist qualified personnel *only*.



WARNING: Disconnect power before servicing. Replace fuses with the specified type and rating *only*.

Maintenance

There are no serviceable parts inside the device. The following points have to be considered when inspecting the fixture for maintenance:

- All screws for installing the devices or parts of the device have to be tightly connected and must not be corroded.
- Mechanically moved parts must not show any traces of wearing and must not rotate with unbalances.
- The electric power supply cables must not show any damage, material fatigue or sediments.

Troubleshooting Error Messages

When you turn on the fixture, it will make a reset at first. The display may show "Err channel is XX" while there are problems with one or more channels. "XX" stands for channel that has the testing sensor for positioning. For example, when the display shows "Err channel is Pan movement", it means there is some error in channel 1. If there are some errors on channel 1 and channel 3 at the same time, you may see the error message "Err channel is Pan movement", "Err channel is Tilt movement" flash twice, and then the fixture will generate a second reset. If the fixture is still not functioning properly, contact High End Systems customer service for assistance.

PAN- movement Er

(PAN-yoke movement error) This message will appear after the reset of the fixture if the yoke's magnetic-indexing circuit malfunction (sensor failed or magnet missing) or the stepping-motor is defective (or its driving IC on the main PCB). The PAN- movement is not located in the default position after the reset.

TILT- movement Er

(TILT-head movement error) This message will appear after the reset of the fixture if the head's magnetic-indexing circuit malfunctions (sensor failed or magnet missing) or the stepping-motor is defective (or its driving IC on the main PCB). The TILT- movement is not located in the default position after the reset.

Appendix A:

MSpeed Conversion Table

The following table lists the MSpeed (motor) movement times and their corresponding DMX controller values. If you have a numeric-type controller, use the Value Decimal (dec.) column. If you have a fader-type controller, use the Value Percentage (%) column. If your controller allows you to program hex values, use the Value (hex) column.

Time (sec.)	Value (dec.)	Value (%)	Value (hex)	Time (sec.)	Value (dec.)	Value (%)	Value (hex)	Time (sec.)	Value (dec.)	Value (%)	Value (hex)
0.15	255	100	FF	5.94	217	85	D9	23.30	179	70	B3
0.15	254	100	FE	6.25	216	85	D8	23.92	178	70	B2
0.17	253	99	FD	6.56	215	84	D7	24.54	177	69	B1
0.19	252	99	FC	6.89	214	84	D6	25.17	176	69	B0
0.21	251	98	FB	7.22	213	84	D5	25.80	175	69	AF
0.25	250	98	FA	7.56	212	83	D4	26.45	174	68	AE
0.29	249	98	F9	7.91	211	83	D3	27.10	173	68	AD
0.35	248	97	F8	8.27	210	82	D2	27.76	172	67	AC
0.41	247	97	F7	8.63	209	82	D1	28.43	171	67	AB
0.47	246	96	F6	9.00	208	82	D0	29.11	170	67	AA
0.55	245	96	F5	9.39	207	81	CF	29.80	169	66	A9
0.63	244	96	F4	9.77	206	81	CE	30.49	168	66	A8
0.73	243	95	F3	10.17	205	80	CD	31.19	167	65	A7
0.83	242	95	F2	10.58	204	80	CC	31.90	166	65	A6
0.94	241	95	F1	10.99	203	80	CB	32.62	165	65	A5
1.05	240	94	F0	11.41	202	79	CA	33.34	164	64	A4
1.18	239	94	EF	11.84	201	79	C9	34.08	163	64	A3
1.31	238	93	EE	12.28	200	78	C8	34.82	162	64	A2
1.45	237	93	ED	12.72	199	78	C7	35.57	161	63	A1
1.60	236	93	EC	13.17	198	78	C6	36.33	160	63	A0
1.75	235	92	EB	13.63	197	77	C5	37.09	159	62	9F
1.92	234	92	EA	14.10	196	77	C4	37.87	158	62	9E
2.09	233	91	E9	14.58	195	76	C3	38.65	157	62	9D
2.27	232	91	E8	15.07	194	76	C2	39.44	156	61	9C
2.46	231	91	E7	15.56	193	76	C1	39.44v	156	61	9C
2.66	230	90	E6	16.06	192	75	C0	40.23	155	61	9B
2.86	229	90	E5	16.57	191	75	BF	41.04	154	60	9A
3.07	228	89	E4	17.09	190	75	BE	41.85	153	60	99
3.29	227	89	E3	17.61	189	74	BD	42.68	152	60	98
3.52	226	89	E2	18.14	188	74	BC	43.50	151	59	97
3.76	225	88	E1	18.68	187	73	BB	44.34	150	59	96
4.00	224	88	E0	19.23	186	73	BA	45.19	149	58	95
4.25	223	87	DF	19.79	185	73	B9	46.04	148	58	94
4.52	222	87	DE	20.36	184	72	B8	46.90	147	58	93
4.78	221	87	DD	20.93	183	72	B7	47.77	146	57	92
5.06	220	86	DC	21.51	182	71	B6	48.65	145	57	91
5.34	219	86	DB	22.10	181	71	B5	49.54	144	56	90
5.64	218	85	DA	22.70	180	71	B4	50.43	143	56	8F

Appendix A
MSpeed Conversion Table

Time (sec.)	Value (dec.)	Value (%)	Value (hex)	Time (sec.)	Value (dec.)	Value (%)	Value (hex)	Time (sec.)	Value (dec.)	Value (%)	Value (hex)
51.33	142	56	8E	102.77	95	37	5F	175.24	46	18	2E
52.24	141	55	8D	104.05	94	37	5E	176.92	45	18	2D
53.16	140	55	8C	105.35	93	36	5D	178.61	44	17	2C
54.09	139	55	8H	106.65	92	36	5C	180.30	43	17	2B
55.02	138	54	8A	107.96	91	36	5B	182.01	42	16	2A
55.96v	137	54	89	109.28	90	35	5A	183.72	41	16	29
56.91	136	53	88	110.61	89	35	59	185.44	40	16	28
57.87	135	53	87	111.94	88	35	58	187.17	39	15	27
58.84	134	53	86	113.28	87	34	57	188.90	38	15	26
59.81	133	52	85	114.63	86	34	56	190.65	37	15	25
60.79	132	52	84	115.99	85	33	55	192.40	36	14	24
61.78	131	51	83	117.36	84	33	54	194.16	35	14	23
62.78	130	51	82	118.73	83	33	53	195.92	34	13	22
63.79	129	51	81	120.12	82	32	52	197.70	33	13	21
64.80	128	50	80	121.5v	81	32	51	199.48	32	13	20
65.82	127	50	7F	122.91	80	31	50	201.28	31	12	1F
66.85	126	49	7E	124.31	79	31	4F	203.08	30	12	1E
67.89	125	49	7D	125.73	78	31	4E	204.88	29	11	1D
68.94	124	49	7C	127.15	77	30	4D	206.70	28	11	1C
69.99	123	48	7B	128.58	76	30	4C	208.52	27	11	1B
71.05	122	48	7A	130.02	75	29	4B	210.36	26	10	1A
72.13	121	47	79	134.39	72	28	48	212.19	25	10	19
73.20	120	47	78	135.86	71	28	47	214.04	24	9	18
74.29	119	47	77	137.34	70	27	46	215.90	23	9	17
75.38	118	46	76	138.82	69	27	45	217.76	22	9	16
76.49	117	46	75	140.32	68	27	44	219.63	21	8	15
77.60	116	45	74	141.82	67	26	43	221.51	20	8	14
78.71	115	45	73	143.33	66	26	42	223.40	19	7	13
79.84	114	45	72	144.85	65	25	41	225.30	18	7	12
80.98	113	44	71	146.38	64	25	40	227.20	17	7	11
82.12	112	44	70	147.92	63	25	3F	229.11	16	6	10
83.27	111	44	6F	149.46	62	24	3E	231.03	15	6	0F
84.43	110	43	6E	151.01	61	24	3D	232.96	14	5	0E
85.59	109	43	6D	152.57	60	24	3C	234.90	13	5	0D
86.77	108	42	6C	154.14	59	23	3B	236.84	12	5	0C
87.95	107	42	6B	155.71	58	23	3A	238.79	11	4	0B
89.14	106	42	6A	157.30	57	22	39	240.75	10	4	0A
90.34	105	41	69	158.89	56	22	38	242.72	9	4	09
91.55	104	41	68	160.49	55	22	37	244.70	8	3	08
92.76	103	40	67	162.09	54	21	36	246.68	7	3	07
93.98	102	40	66	163.71	53	21	35	248.68	6	2	06
95.21	101	40	65	165.33	52	20	34	250.68	5	2	05
96.45	100	39	64	166.96	51	20	33	246.68	7	3	07
97.70	99	39	63	168.60	50	20	32	248.68	6	2	06
98.95	98	38	62	170.25	49	19	31	250.68	5	2	05
100.22	97	38	61	171.91	48	19	30	252.68	4	2	04
101.49	96	38	60	173.57	47	18	2F				